



Star Accessories  
Roadliner®/ Stratoliner®  
Raider  
VMAX®  
Warrior®  
Road Star®  
Royal Star Tour Deluxe®  
Royal Star Venture®  
Royal Star®  
V Star® 1300  
V Star® 950  
V Star® 1100/ V Star® 650  
V Star® 250  
Star Wheel Kits  
Speedstar® Competition Products  
“Distributed by Yamaha” Accessories

**Roadliner®/ Stratoliner® Accessories**



**Comfort Cruise™ Seat**

The Comfort Cruise seat offers a new dimension of riding comfort. Whether you're going across town or across the country, Star Custom Accessories has a seat that is just right for your riding style.

Features include:

- Traditional styling and quality that you have come to expect from all Star Custom Accessories
- Luxurious real leather seating panels
- Hand-laid fiberglass seat pan for consistent fit
- Soft foam edges for added comfort and protection for painted surfaces
- Soft foam nose for a close fit to the tank
- Custom foam formulation for a "soft-to-touch" feel along with firmness and support for an all-day ride

**1. Solo Seat**

Plain  
**STR-1D724-10-01** \$374.95

**Comfort Cruise™ Pillion Pad**

The Comfort Cruise pillion pad offers a new dimension of passenger comfort. Designed to coordinate with Comfort Cruise Solo Seats to give your bike the right look, with a comfortable feel your passenger will appreciate.

**2. Tour**

Plain  
**STR-1D725-30-01** \$257.95

**3. Custom Backrest Pad**

Plain  
**STR-5GA41-50-00** \$107.95

**Quick Release Passenger Backrest System**

Three-piece, quick release system provides an easy-on, easy-off solution to passenger comfort. Polished and chrome plated sidearms and upright are sold separately. Backrest pad is constructed of durable vinyl and designed to coordinate with the stock Roadliner and Stratoliner seats. Protect your investment with the optional lock kits (sold separately).

**4. Passenger Backrest Upright**

Tall  
**STR-2C541-30-02** \$155.95

**5. Passenger Backrest Sidearms**

**STR-2C541-10-00** \$221.95

**6. Passenger Backrest Pad**

Plain  
**1D6-2840F-00-00** \$143.83



## 7. Hard Leather Sidebags

Locking sidebags with premium leather covering. These sidebags are sculpted to fit the flowing lines of the Roadliner, with a combined volume of 2860 cubic inches. These bags are capable of holding a half helmet. Quick-release fasteners offer easy removal for cleaning. Lock kit and mounting hardware sold separately. Maximum weight limit 10 lb. each.

**STR-2C573-00-00** \$1,175.95

## Mounting Hardware

**STR-2C573-40-00** \$214.95

## 8. Saddlebag Liners

Liners provide carry-away convenience for your luggage. Constructed of heavy-duty ballistic nylon for durability, and an embroidered Star logo for a quality look and feel. Saddlebag liners are sold in pairs.

**STR-4XY73-90-00** \$80.95

## 9. Soft Throw-Over Saddlebags

Designed specifically for the Roadliner. Features include handcrafted leather construction, sturdy zippers, and handles for quick-release convenience. Fastex® buckles for easy access and a molded ABS back plate with a steel frame to help hold the bags shape when empty. Requires installation of Saddlebag Support Bars (STR-1D773-40-00) sold separately.

Fits all Roadliner models

**STR-1D773-55-01** \$369.95

## 10. Saddlebag Support Bars

Designed to help keep saddlebags off the fender and allow clearance for swingarm movement. (Sold in pairs.)

Fits all Roadliner models

**STR-1D773-40-00** \$115.95

## 11. Optional Lock Kit

This lock set includes a full set of locks and matching keys for the windshield, backrest, and sidebags.

**STR-2C590-10-00** \$80.95

## 12. Mini Tank Cover

This soft leather mini cover simply attaches to the fuel tank. Looks good and helps protect the paint from pant leg wear.

**STR-1D749-50-00** \$53.95



## 13a. Mink Oil

Use to waterproof, preserve and protect your leather accessories.

4-oz. Jar

**ACC-MINKC-RE-AM** \$2.95

## 13b. Saddle Soap

Use to clean, condition and restore your leather accessories.

4-oz. Jar

**ACC-SADDL-ES-AP** \$2.95

## 13c. Black Leather Polish

Use to restore black leather to its natural luster by putting color back into the leather.

1.5-oz. Jar

**ACC-CREAM-PL-SH** \$2.49



### Billet Mirrors

Designed for a classy, yet aggressive personality, while maintaining excellent visibility. Available in two different head shapes, and a smooth chrome finish that coordinates with accessory and original-equipment components. Left and right hand mirrors sold separately.

#### 1. Oval

Smooth, Left	
<b>STR-1D713-41-00</b>	\$129.95
Smooth, Right	
<b>STR-1D713-42-00</b>	\$129.95

#### 2. Tear Drop

Smooth, Left	
<b>STR-1D713-21-00</b>	\$129.95
Smooth, Right	
<b>STR-1D713-22-00</b>	\$129.95

### 3. Billet Passenger Floorboards

Our newly designed passenger floorboards incorporate a molded rubber cushion for comfort and added durability. Polished and clear powder-coated passenger floorboards coordinate with the stock rider floorboards. Requires passenger floorboard mounts (STR-1D757-40-00), sold separately.

<b>STR-1D757-30-07</b>	\$232.95
------------------------	----------

Passenger Floorboard Mounts  
(Not shown)

<b>STR-1D757-40-00</b>	\$89.95
------------------------	---------

#### 4. Billet Brake Pedal Cover

Unique clamshell design replaces the stock rubber brake pedal cover. Highly polished to provide a durable and rich chrome finish. Machined billet housing with replaceable rubber inserts.

**STR-1D727-12-03** \$86.95

Replacement Rubber Insert

**STR-1D727-12-98** \$19.95

#### 5. Billet Single Arm Shift Lever

Replace the stock heel/ toe shifter with this billet single arm shifter. Styled to coordinate with the billet brake pedal cover. Replaceable rubber inserts.

**STR-1D738-10-00** \$118.95

Replacement Rubber Inserts

**STR-1D738-10-98** \$18.95

#### 6. Billet Shift Arm with Heel Shifter

All the style of the single arm shifter, while retaining the stock heel shifter. The heel shifter has been moved back 1 inch to allow for more foot room on longer rides. (Dealer installation recommended.)

**STR-1D738-20-00** \$150.95

Replacement Rubber Inserts

**STR-1D738-10-98** \$18.95

#### 7. Billet Shift Linkage

Replace the stock shift linkage with these polished and chrome-plated billet pieces.

Smooth

**STR-1D727-67-01** \$50.95

Slotted

**STR-1D727-67-08** \$50.95

#### 8. Billet Brake Caliper Covers

These highly polished and chrome-plated billet aluminum covers are adhesive backed for easy installation. (Two-piece set.)

**STR-1D727-16-01** \$86.95

#### 9. Billet Rear Axle Covers

Cool billet covers complement our stylish swingarm. Requires removal of rear axle. (Dealer installation recommended.)

**STR-1D727-57-01** \$160.95

#### 10. Billet Swingarm Pivot Covers

Precision-machined billet-aluminum, highly polished and chrome-plated. Replaces stock plastic covers.

**STR-1D727-54-01** \$65.95

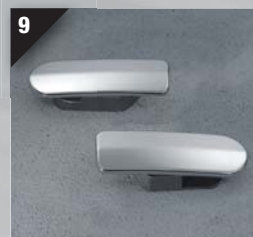
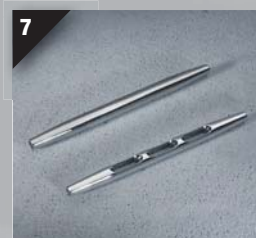

#### 11. Front Fender Trim Rail

Dynamic new design specifically styled to coordinate with the flowing lines of the Roadliner and Stratoliner models. (Not compatible with front fender tip.)

**STR-1D714-10-00** \$267.95



#### 12. Chrome Metal Fender Tips

Cast metal fender tips are polished and then chrome-plated to a brilliant finish for a classic look. (Installation requires drilling of fenders.)

Front of Front Fender

**STR-1D726-90-00** \$65.95

Rear of Front Fender

**STR-1D726-91-00** \$80.95

Rear Fender

**STR-1D726-92-00** \$97.95



## JEFF PALHEGYI SIGNATURE SERIES -

### custom accessories from one of today's top bike builders

Bike builder Jeff Palhegyi is the architect of many of the most admired customized Star motorcycles ever crafted. His creative work has appeared in top motorcycle shows and has been frequently featured in Custom Star calendars. Those lucky enough to own a motorcycle from Palhegyi Designs

can count on attracting plenty of attention. Palhegyi's talent and creative vision have earned him recognition as one of the world's top custom bike designers. His artistry has been acknowledged in over 40 articles in national magazines, and he has made many TV appearances, including documentaries on SPEED TV ("V-Twin TV" and "Epic Rides"). Palhegyi customs have also been showcased in the IMS Tour in the United States, the Tokyo Motor Show in Japan, and the INTERMOT® and Milan shows in Europe.

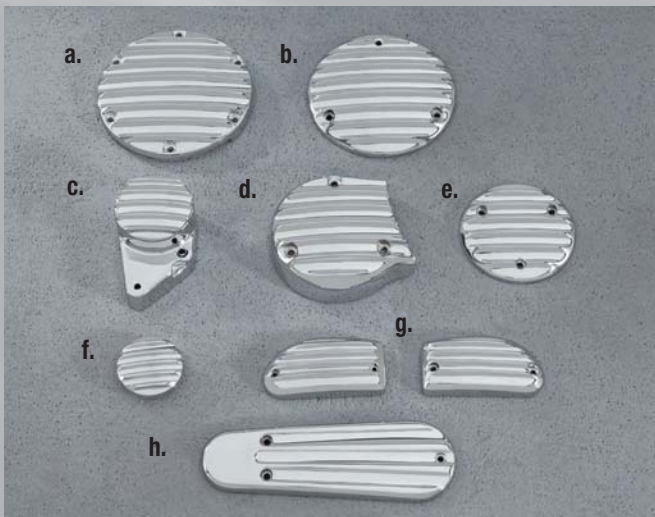

Chrome Bomber Components

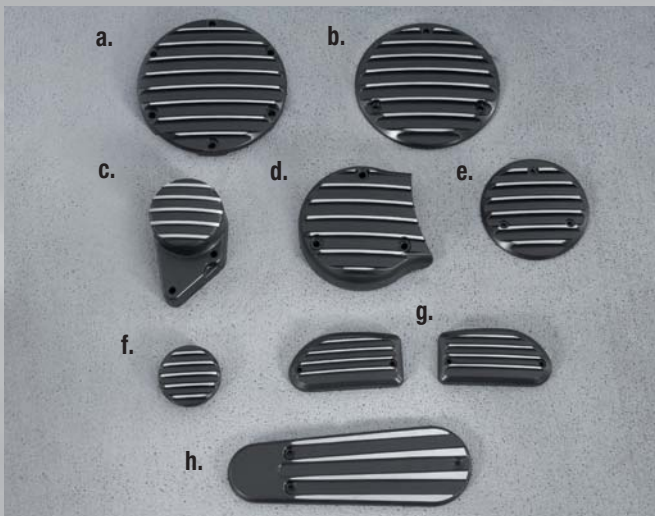

Midnight Bomber Components

## Custom "Bomber" Components

Jeff Palhegyi has designed these custom Bomber-series chrome components exclusively for Star Motorcycles. Bomber covers are available either polished and plated to a show-quality chrome finish or in the "Midnight" collection for a blacked-out look detailed with brushed fin edges. Bomber components have a coordinated look to give your bike a true custom look.

Fits '06-'10 Roadliner & Stratoliner

### a. Drive Pulley Cover Insert

A simple bolt on application with a radical change to the look of the motor. Replaces stock drive pulley cover insert and coordinates with other "Bomber" accessories.

Chrome	
<b>STR-1D727-81-02</b>	\$119.95
Midnight	
<b>STR-1D727-81-03</b>	\$113.95

### b. Clutch Cover Insert

A simple bolt on application with a radical change to the look of the motor. Replaces stock clutch cover insert and coordinates with other "Bomber" accessories.

Chrome	
<b>STR-1D727-43-02</b>	\$109.95
Midnight	
<b>STR-1D727-43-03</b>	\$99.95

### c. Starter Cover

Simple bolt-on design covers the existing starter end cap for a clean finish. Coordinates with other "Bomber" accessories.

Chrome	
<b>STR-1D727-46-02</b>	\$99.95
Midnight	
<b>STR-1D727-46-03</b>	\$99.95

### d. Ignition Cover

Replace your plain stock ignition cover with this totally redesigned cover to complete the bomber package.

Chrome	
<b>STR-1D727-27-00</b>	\$129.95
Midnight	
<b>STR-1D727-27-01</b>	\$123.95

### e. Generator Cover Insert

A simple bolt on application with a radical change to the look of the motor. Replaces stock generator cover insert and coordinates with other "Bomber" accessories.

Chrome	
<b>STR-1D727-47-02</b>	\$64.95
Midnight	
<b>STR-1D727-47-03</b>	\$61.95

### f. Cam Cover Insert

A simple bolt on application with a radical change to the look of the motor. Replaces stock cam cover insert and coordinates with other "Bomber" accessories.

Chrome	
<b>STR-1D727-41-02</b>	\$49.95
Midnight	
<b>STR-1D727-41-03</b>	\$47.95

### g. Master Cylinder Cover Set

Attach these to the clutch and front brake master cylinders for a personalized, highly polished, chrome-plated look.

Chrome	
<b>STR-1D718-10-01</b>	\$99.95
Midnight	
<b>STR-1D718-10-02</b>	\$94.95

### h. Primary Drive Cover Insert

A simple bolt on application with a radical change to the look of the motor. Replaces stock primary drive cover insert hiding the fill level plug and coordinates with other Bomber accessories.

Chrome	
<b>STR-1D727-82-02</b>	\$99.95
Midnight	
<b>STR-1D727-82-03</b>	\$94.95

## Star Custom Accessory Windshields

Our tough polycarbonate windshields not only offer the superior fit and finish you would expect, we went a step further by treating them with the new-generation Quantum™ Coating to provide a long lasting, durable, protective finish. This makes the windscreen three times more scratch-resistant than typical acrylic products, and also much more resistant to damage from bugs, stone chips, road grime, or even everyday cleaning. This extra attention to detail will help keep your windshield looking new longer, and that's a clear benefit you'll enjoy on every ride.

### 1. Windshields

Available in three heights\*\*. Medium is the same height as Stratoliner. The unique quick-release feature allows for quick change of your windshield before riding, due to a change in weather or attitude. For added security, install the lock kit (STR-2C590-10-00). Windshield mounts (STR-2C503-40-00), the same as those used on the Stratoliner, are required on Roadliner models. Windshield mounts and lock kits sold separately.

Windshield Assemblies

Tall (24-5/8"\*\*)

**STR-2C503-10-00** \$399.95

Medium (21-5/8"\*\*)

**STR-2C507-10-00** \$389.95

Short (16-3/8"\*\*)

**STR-2C506-10-00** \$386.95

Replacement Windshields

Tall (24-5/8"\*\*)

**STR-2C503-11-00** \$150.95

Medium (21-5/8"\*\*)

**STR-2C507-11-00** \$150.95

Short (16-3/8"\*\*)

**STR-2C506-11-00** \$150.95

Quick Release Windshield Mounts

**STR-2C503-40-00** \$199.95

### 2. Passing Lamps

Unique two-bulb design. Passing lamp mounts (STR-2C535-40-00) sold separately. (Dealer installation recommended.)

**STR-2C535-10-00** \$118.95

### Passing Lamp Mounts

Patented design offers improved adjustability.

**STR-2C535-40-00** \$182.95

### NEW! Replacement Reflector/

#### Lens Bulbs

(Not shown)

**STR-2C535-60-00** \$15.12

### 3. Optional Lock Kit

This lock set includes a full set of locks and matching keys for the windshield, backrest, and sidebags.

**STR-2C590-10-00** \$80.95



These accessories fit all Roadliner and Stratoliner models unless otherwise noted.  
\*\*Height measured from top of headlight cutout to top of windshield.

### 1. Billet Rear Fender Rack

A new twist on an old standard. This rear fender rack is machined out of 6061-billet aluminum then polished and chrome-plated. Not compatible with passenger seat.

Ribbed  
STR-1D751-40-00 \$166.95

### 2. Rear Luggage Rack

Designed specifically for the Stratoliner, this new rack attaches to the passenger backrest and retains the quick release features. Can also be used on Roadliner if Backrest (sold separately) is installed.

STR-2C551-30-00 \$113.95

### 3. Big Bar Engine Guards

The styling of these big 1-1/4" chrome engine guards fit perfectly with the sleek styling of the Roadliner and Stratoliner.

STR-1D731-20-00 \$214.95

### **⚠ WARNING**

These engine guards may provide limited protection against cosmetic vehicle damage in certain situations, such as if the motorcycle tips over while stopped or moving slowly. These engine guards are not manufactured or intended to protect the rider from injury in a collision.

### 4. Sidebag Guards

Polished and chrome-plated for style and function. They help protect stock the Stratoliner or accessory Hard Leather Sidebags if your bike is dropped. Saddlebag mounts (STR-2C573-40-00) required for mounting on Roadliner.

STR-2C533-00-00 \$214.95

### 5. Sidebag Trim Rails

These polished and chrome-plated trim rails wrap around the Stratoliner sidebags adding to the flowing lines of the motorcycle. Requires sidebag mounts and guards for installation.

STR-2C572-70-00 \$214.95





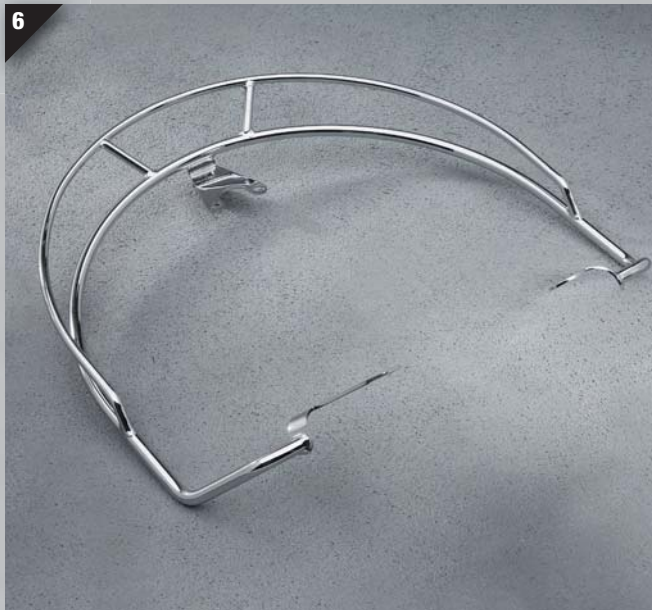

## 6. Solo Seat Rail

Styled to complement both stock and Star custom seats, this uniquely designed seat rail is polished and chrome-plated to a show-worthy appearance. Rail is for solo-seat application only and not compatible with passenger seats.

**STR-1D724-60-01** \$193.95

## 7. Custom License Frames

These custom frames are available in two finishes. Smooth style features a 1/2" round molded edge with a clear license cover and chrome backing plate. Ball milled style features chrome-plated billet-aluminum construction with Star logo and chrome backing plate. Chrome mounting hardware is included with both styles.

Smooth  
**STR-4NK26-25-00** \$59.95

Ball Milled  
**STR-4NK27-01-03** \$96.95

## 8. Billet License Plate Frame

Compact billet license frame kit includes all hardware and backing plate.

Smooth  
**STR-5PX27-01-01** \$81.95

Ball Milled  
**STR-5PX27-01-07** \$83.95



## 9. Braided Stainless Steel Throttle Cable Set

Upgrade the appearance of your Roadliner or Stratoliner by replacing the stock black cables with these stainless steel braided cables built to exacting stock specifications. Nylon inner liner for smooth operation. Each cable has a rugged clear coat on its full length to make it easier to clean, while helping to protect windshields and painted surfaces. (Dealer installation recommended.)

**STR-1D748-10-SD** \$86.95



## 10. Braided Stainless Steel Brake and Clutch Lines

All of our hydraulic lines are constructed using 308 stainless steel braided brake hose with a Teflon® inner liner. The lines have a rugged clear coat on its full length to make it easier to clean, while helping to protect windshields and painted surfaces. (Dealer installation recommended.)

Clutch Line  
**STR-1D748-20-SD** \$59.95

Front Brake Line  
**STR-1D748-30-SD** \$123.95

Rear Brake Line  
**STR-1D748-50-SD** \$75.95

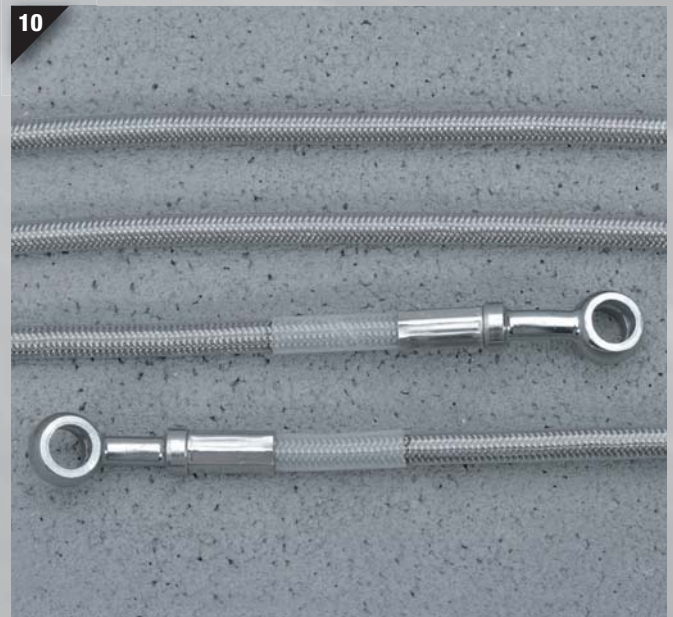



### 1. Long Drag Exhaust System

Designed to maximize exhaust flow for increased performance, with more mid-range torque and higher overall power. This system features 1-3/4" header pipe with 2-3/8" full-coverage heat shields. Heat shields are constructed of heavy-gauge steel and then polished and richly chrome-plated for an extra-durable, shiny finish. Baffles are non-removable. Comes complete with mounting bracket and hardware.

**SPD-1D709-90-02** \$579.95

*For closed-course use only (see Important Note below).*



Roadliner shown with Star Custom Accessories and custom paint

**IMPORTANT NOTE:**

*All Star models are regulated by the EPA and state law. This accessory affects exhaust emissions and is for closed-course competition only. Use on public roads constitutes illegal tampering punishable by law.*

These accessories fit all Roadliner and Stratoliner models unless otherwise noted.

**Raider® Accessories****Comfort Cruise™ Seats**

Comfort Cruise seats offer a new dimension of riding comfort. Whether you're going across town or across the country, Star Custom Accessories has a seat that is just right for your riding style.

Features include:

- Traditional styling and quality that you have come to expect from all Star Custom Accessories
- Luxurious real leather seating panels
- Hand-laid fiberglass seat pan for consistent fit
- Soft foam edges for added comfort and protection for painted surfaces
- Soft foam nose for a close fit to the tank
- New foam formulation for a "soft-to-touch" feel along with firmness and support for an all-day ride

**1. Comfort Cruise™ Stiletto Seat**

Aggressive low slung design with comfort to go the miles, this seat features faux rhino leather seating panel inserts.

**STR-5C722-30-00**     \$374.95

**2. Comfort Cruise™ Solo Seat**

This latest generation of our Comfort Cruise™ seats include all the same features you have come to expect from Star Custom Accessories and now include a receptacle for our adjustable rider backrest system (backrest sold separately). Looks great by itself or with our Comfort Cruise™ Pillion Pad (sold separately).

**STR-5C724-10-00**     \$389.95

**3. Comfort Cruise™ Pillion Pad**

This Comfort Cruise™ pillion pad offers a new dimension of passenger comfort. Designed to coordinate with the Comfort Cruise Solo Seat. Faux rhino leather seating inserts. Not compatible with the stock seat.

**STR-5C725-00-00**     \$249.95

**4. Comfort Cruise™ Dual Touring Seat**

This seat combines the comfort of a touring bike with the styling of a custom. With sculpted seating positions and leather seating panels, this seat delivers maximum comfort. Includes a receptacle for removable rider backrest. Seat is fully compatible with our Quick Release Backrest. Faux rhino leather seating inserts. Our removable Comfort Cruise Rider backrest (sold separately) is angle-adjustable for added comfort.

**STR-5C721-10-00**     \$499.95



## 1. Comfort Cruise™ Rider Backrest Pad

Fits both Comfort Cruise Solo and Dual Touring Seats. Requires Comfort Cruise™ Rider Backrest Plug-In Bracket (STR-3D821-12-00) for installation. Not compatible with stock rider seat.

**STR-5C721-15-00** \$79.95



## Comfort Cruise™ Rider Backrest Plug-In Bracket

(Shown with Comfort Cruise™ Rider Backrest Pad in #1)

Required for installation of Comfort Cruise™ Rider Backrest Pad on either the Comfort Cruise Solo or Dual Touring Seat.

**STR-3D821-12-00** \$89.95



## Quick Release Backrest

This uniquely styled, quick release die cast backrest is there when it's needed and gone when it's not. The lockable base and uprights are die-cast then polished and chrome plated to a show worthy appearance.



## 2. Backrest Base

Die-cut and then polished and plated. Backrest base, uprights and backrest pads are all sold separately.

**STR-5C743-10-00** \$389.95

## 3. Backrest Upright

These backrest uprights are die-cast then polished and chrome plated to a show worthy appearance. Uprights are available in two heights, Tall (10-1/4") and Short (7-1/8"). Designed to be used with the Quick Release Backrest Base (STR-5C743-10-00), sold separately. Two backrest pad options available.

**a.** Tall (10-1/4")

**STR-5C743-30-00** \$79.95

**b.** Short (7-1/8")

**STR-5C743-20-00** \$64.95

## 4. Backrest Pad

Uniquely styled backrest pads designed to be used in conjunction with the Quick Release Backrest Base and Backrest Upright (both sold separately).

**a.** Custom

(coordinates with Comfort Cruise seat)

**STR-5C740-10-00** \$89.95

**b.** Standard

(coordinates with stock seat)

**STR-5C740-00-00** \$84.95



5



### 5. Cruiselite® Custom Soft Saddlebags

New compression-molded construction allows for bold new styling designed specifically for the Raider. These detachable bags feature a synthetic leather finish with textured inserts, expandable from 1845~2711 cu. in. Detachable feature allows for easy carry-away convenience. Maximum carrying weight 7 lb. each. Requires installation of Saddlebag Support Bars (STR-5C773-40-00) sold separately.  
**STR-5C773-70-00** \$197.95

6



### 6. Cruiselite® Custom Soft Tank Bag

Compression-molded construction allows for bold styling designed specifically for the Raider. Features include weatherproof non-glare map pocket, synthetic leather finish with textured inserts, and chrome accents. A special internal MP3 player or iPod® pocket is provided along with a water-resistant external port for the headphone wire. For carry-away convenience, the tank bag attaches with special high-strength magnets shielded to help protect electronic devices you may be carrying. Maximum carrying weight limit is 3 lb. The expandable feature increases its capacity from 346 cu. in. to over 500 cu. in.  
**STR-5C764-21-00** \$110.95

7

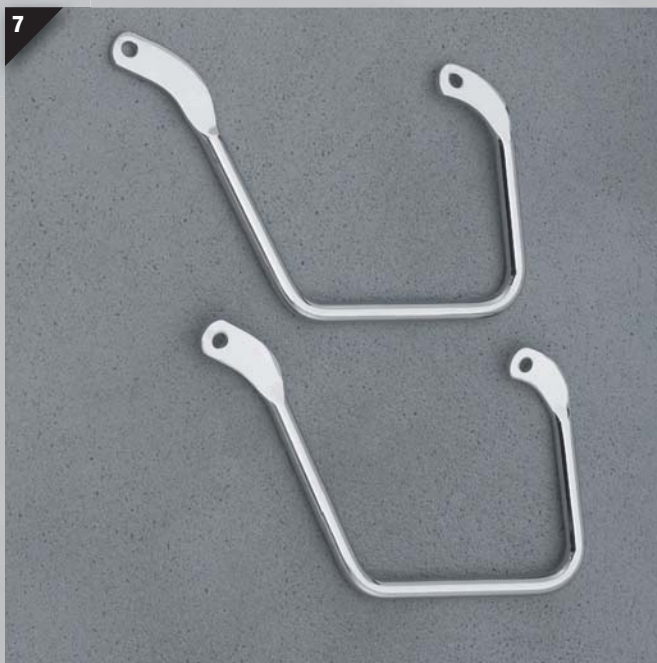

### 7. Saddlebag Support Bars

Designed to help keep saddlebags off the fender and allow clearance for swingarm movement. For use with or without Quick Release Backrest. (Sold in pairs.)  
**STR-5C773-40-00** \$119.95

## Billet Mirrors

Designed for an aggressive personality, while maintaining excellent visibility. Available in two different head shapes, and a smooth chrome finish that coordinates with Star accessories and original equipment components. Left and right hand mirrors sold separately.

### 1. Oval

Smooth, Left

**STR-1D713-41-00** \$129.95

Smooth, Right

**STR-1D713-42-00** \$129.95

### 2. Tear Drop

Smooth, Left

**STR-1D713-21-00** \$129.95

Smooth, Right

**STR-1D713-22-00** \$129.95

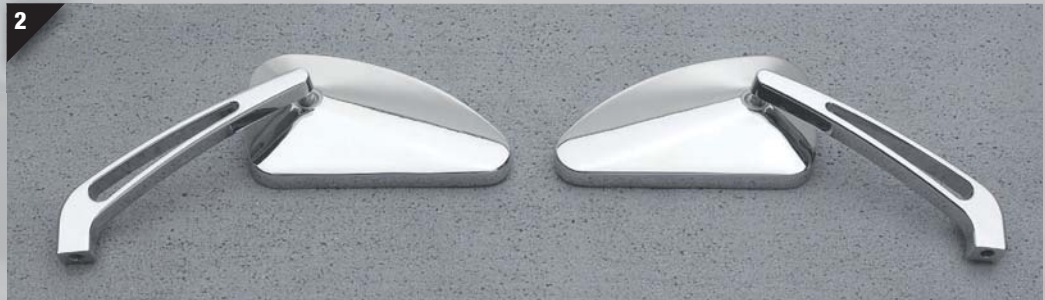

### 3. Billet Rider Foot Pegs

Billet foot pegs that coordinate with other Star accessories. Pegs include unique replaceable rubber inserts. (Sold in pairs.)

Chrome

**STR-5PX36-70-01** \$134.95

Replacement Rubber Inserts

(Order two if replacing rubber on both pegs).

**STR-5PX36-70-98** \$17.95

### 4. Billet Passenger Foot Pegs with Rubber Inserts

Replace the stock passenger pegs with these stylish and functional passenger foot pegs. Pegs coordinate with the Billet Rider Foot Pegs and include unique replaceable rubber inserts. (Sold in pairs.)

Chrome

**STR-5PX36-10-01** \$96.95

### 5. Chrome Passenger Foot Pegs with Rubber Inserts

Chrome-plated foot pegs designed to replace stock passenger pegs. All necessary hardware included for easy installation and proper fit. (Sold in pairs.)

**STR-5BN36-20-03** \$65.95

### 6. Billet License Plate Frames

Compact billet license frame kit includes all hardware and backing plate.

Smooth

**STR-5PX27-01-01** \$81.95

Brushed

**STR-5PX27-01-07** \$83.95



## Custom “Bomber” Components

Jeff Palhegyi has designed these custom Bomber-series chrome components exclusively for Star Motorcycles. Bomber covers are available either polished and plated to a show-quality chrome finish or in the “Midnight” collection for a blacked-out look detailed with brushed fin edges. Bomber components have a coordinated look to give your Raider a true custom look.

### a. Drive Pulley Cover Insert

Replaces stock drive pulley cover insert. A simple bolt on application with a radical change to the look of the motor.

Chrome	
<b>STR-1D727-81-02</b>	\$119.95
Midnight	
<b>STR-1D727-81-03</b>	\$113.95

### b. Clutch Cover Insert

Replaces stock clutch cover insert. A simple bolt-on application with a radical change to the look of the motor.

Chrome	
<b>STR-1D727-43-02</b>	\$109.95
Midnight	
<b>STR-1D727-43-03</b>	\$99.95

### c. Starter Cover

Simple bolt-on design covers the existing starter end cap for a clean finish.

Chrome	
<b>STR-1D727-46-02</b>	\$99.95
Midnight	
<b>STR-1D727-46-03</b>	\$99.95

### d. Ignition Cover

Replace your plain stock ignition cover with this totally redesigned cover to complete the bomber package.

Chrome	
<b>STR-1D727-27-00</b>	\$129.95
Midnight	
<b>STR-1D727-27-01</b>	\$123.95

### e. Generator Cover Insert

Replaces stock generator cover insert. A simple bolt-on application with a radical change to the look of the motor.

Chrome	
<b>STR-1D727-47-02</b>	\$64.95
Midnight	
<b>STR-1D727-47-03</b>	\$61.95

### f. Cam Cover Insert

Replaces stock cam cover insert to provide a radical change to the look of the motor.

Chrome	
<b>STR-1D727-41-02</b>	\$49.95
Midnight	
<b>STR-1D727-41-03</b>	\$47.95

### g. Master Cylinder Cover Set

Attach these to the clutch and front brake master cylinders for a personalized look.

Chrome	
<b>STR-1D718-10-01</b>	\$99.95
Midnight	
<b>STR-1D718-10-02</b>	\$94.95

### h. Primary Drive Cover Insert

Replaces stock primary drive cover insert hiding the fill level plug. A simple bolt-on application with a radical change to the look of the motor.

Chrome	
<b>STR-1D727-82-02</b>	\$99.95
Midnight	
<b>STR-1D727-82-03</b>	\$94.95



## JEFF PALHEGYI SIGNATURE SERIES - custom accessories from one of today's top bike builders

Bike builder Jeff Palhegyi is the architect of many of the most admired customized Star motorcycles ever crafted. His creative work has appeared in top motorcycle shows and has been frequently featured in Custom Star calendars. Those lucky enough to own a motorcycle from Palhegyi Designs

can count on attracting plenty of attention. Palhegyi's talent and creative vision have earned him recognition as one of the world's top custom bike designers. His artistry has been acknowledged in over 40 articles in national magazines, and he has made many TV appearances, including documentaries on SPEED TV (“V-Twin TV” and “Epic Rides”). Palhegyi customs have also been showcased in the IMS Tour in the United States, the Tokyo Motor Show in Japan, and the INTERMOT® and Milan shows in Europe.

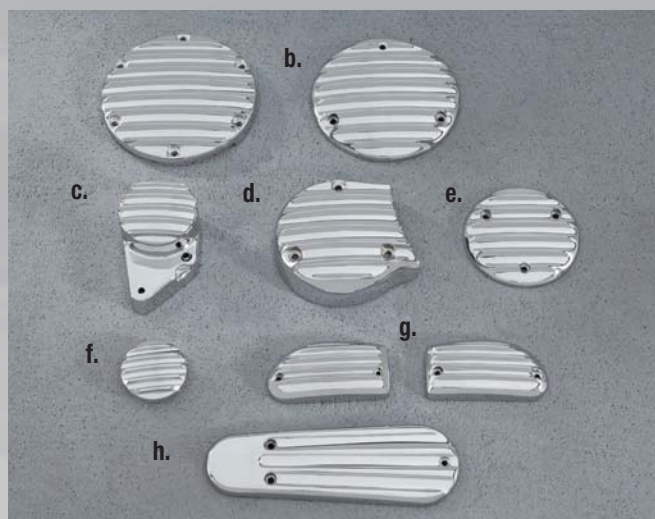

Chrome Bomber Components

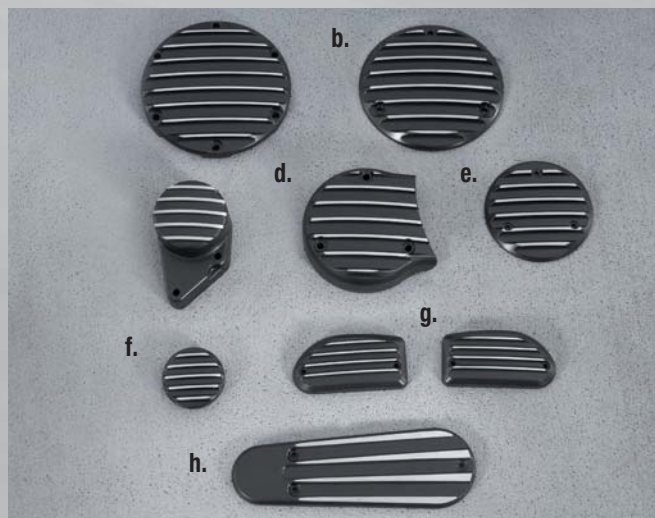

Midnight Bomber Components

These accessories fit all Raider models unless otherwise noted.

## 1. Quick-Release Windshield

Made of tough 4.5mm polycarbonate treated with the new-generation Quantum™ Coating to provide a long lasting, durable, protective finish. This makes the windscreen three times more scratch-resistant than typical acrylic products, and also much more resistant to damage from bugs, stone chips, road grime, or even everyday cleaning. This extra attention to detail will help keep your windshield looking new longer, and that's a clear benefit you'll enjoy on every ride.

Available in two heights\*\*. The unique quick release feature allows you to quickly change your windshield before riding due to a change in weather or attitude. A lock is included for added security. Replacement windscreens are also available. Quick Release Windshield Mounts (STR-5C703-41-00) are required for installation, sold separately.

Tall Windshield (19"\*\*)

**STR-5C703-30-00** \$425.95

Short Windshield (14"\*\*)

**STR-5C706-30-00** \$415.95

Tall Replacement Windshield

**STR-5C703-11-00** \$133.95

Short Replacement Windshield

**STR-5C706-11-00** \$123.95

## 2. Quick-Release Windshield Mounts

These quick release mounts allow you to easily change out your accessory windshield. Required for installation of Quick Release Windshield (Tall or Short), sold separately.

**STR-5C703-41-00** \$149.95

## 3. Boulevard™ Windshield

This 10-3/4" high\*\* windscreen is made of tough 4.5mm polycarbonate with new generation Quantum™ Coating. Smoked shield and chrome-plated trim provides unique styling and deflects wind from your chest area. Includes polished stainless steel mounting hardware.

**STR-5C705-30-00** \$179.95

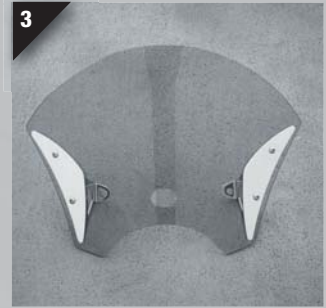

## 4. Passing Lamps

Totally unique design. These passing lamps have 35-watt halogen bulbs and incorporate DOT-approved LED turn signals/marker lights, eliminating the stock turn signals. The mounting system allows for easy adjustment and wiring into an integrated wire harness. Passing Lamp Mounts (STR-5C735-40-00) required for installation, sold separately.

**STR-5C735-10-00** \$261.95

Passing Lamp Mounts

**STR-5C735-40-00** \$104.95



## 5. Chrome Engine Guards

1" diameter polished and chrome plated tubing designed to match the Raider's wild style.

**STR-5C731-10-00** \$236.95



## 6. Billet Rear Fender Rack

This billet rear fender rack is made of 6061 machined billet aluminum then polished and chrome-plated. Works with either the stock solo or Comfort Cruise seats. Requires removal of passenger seat.

**STR-5C751-40-00** \$166.95



## 7. Rear Luggage Rack

This billet luggage rack is designed to be used with the accessory passenger backrest components.

**STR-5C751-30-00** \$144.95



\*\*Height measured from top of headlight cutout to top of windshield.



### 8. Speedstar® Staggered Long Drag Exhaust

Designed to maximize exhaust flow for increased performance with more mid-range torque and overall power. This system features 1-3/4" header pipe with 2-3/8" full-coverage heat shields. Heat shields are constructed of heavy-gauge steel then polished and richly chrome-plated for an extra-durable, shiny finish. Baffles are non-removable. Comes with mounting bracket and hardware.

**SPD-5C709-90-02** \$797.95

*For closed-course use only (see Important Note below)*



### 9. Custom Cover

This unique and versatile cover accommodates a fully accessorized Raider while maintaining a custom-fit look. The top half uses premium Evolution® 4 fabric that is breathable, water repellent and UV-resistant. Incorporates an expandable backrest pocket. The bottom half is constructed of duck canvas for heat protection against exhaust pipes. Both materials provide excellent outdoor protection. (Not recommended for trailering.)

**STR-5C728-00-00** \$144.95



#### IMPORTANT NOTE:

*All Star models are regulated by the EPA and state law. This accessory affects exhaust emissions and is for closed-course competition only. Use on public roads constitutes illegal tampering punishable by law.*

These accessories fit all Raider models unless otherwise noted.

**VMAX® Accessories**

**1. Stiletto Cowl**

Replace the stock passenger seat for a “cockpit” look and feel while retaining easy fuel access. Not suitable for use as a passenger seat.  
**2S3-F47F0-V0-00**     \$239.95



**2. Low Profile Passenger Backrest**

These die-cast passenger support bars are designed to integrate into the strong lines of the VMAX. Includes sidearms, upright, and pad.  
**2S3-F84U0-V0-00**     \$399.95



**3. Luggage Rack**

This aluminum rack is formed and finished to coordinate with other VMAX accessories. Includes a notch for mounting the tail pack. 10 lb. weight limit. Attaches to Low Profile Passenger Backrest (2S3-F84U0-V0-00), sold separately.  
**2S3-F48B0-V0-00**     \$89.95



**4. Hard Saddlebags**

These hard saddlebags have a soft covering that coordinates with the rider seat and they bolt on directly to the bike for a fully integrated look. Offers a total of over 1050 cubic inches of storage capacity. Formed aluminum accents coordinate with other VMAX components. Includes hardware to mount to the Low Profile Passenger Backrest (2S3-F84U0-V0-00), or use the Saddlebag Mount Kit (2S3-F84G0-V0-00), each sold separately. Weight limit is 7 lb. per bag.  
**2S3-F84H0-V0-00**     \$499.95



**Saddlebag Mount Kit**

(Not shown)  
Allows mounting of the Hard Saddlebags without the Low Profile Passenger Backrest.  
**2S3-F84G0-V0-00**     \$35.95

**5. Tail Pack**

This convenient expandable storage pack attaches to either the passenger seat or luggage rack (sold separately). A concealed expansion joint allows the capacity to increase from 325 cubic inches to 450 cubic inches. Unique “X” bottom design slips onto luggage rack. Made of tough, thermo-formed HDPE with a formed aluminum plate that coordinates with saddlebags and other VMAX components.  
**2S3-F47G0-V0-00**     \$229.95

**6. Billet Swing Arm Pivot Cover Set**

Accent the appearance by replacing the stock pivot covers with these billet components. Two piece set.  
**2S3-F53N0-V0-00**     \$91.95



**7. Billet Cam Cover Set**

CNC-machined aircraft quality aluminum components replace stock cam covers to change the look of this awesome engine. (Eight piece set.)  
**2S3-E54G0-V0-00**     \$277.95

**8. Billet Master Cylinder Covers**

Attach these billet covers to the clutch and front brake master cylinder to coordinate with other VMAX billet accessories. (Two piece set.)  
**2S3-F58D0-V0-00**     \$114.95

**9. Competition Engine Control Unit**

For sanctioned closed-course competition only.  
**2S3-H59B0-V0-00**     \$849.95

## Carbon Fiber Components

Genuine carbon fiber components that bring the tradition of ultra-lightweight, race-winning high performance to the raw sculpted beauty of the VMAX with the fit and finish that can only be expected from Star® Custom Accessories. These components not only embody the strong image of VMAX, they also offer significant weight savings over the stock components they replace.

### 10. Carbon Fiber Intake Runner Set

These carefully handcrafted carbon fiber intake runners replace the stock aluminum runners for a custom, high performance appearance and substantial weight savings.

**2S3-F41F0-V0-00** \$999.95

### 11. Carbon Fiber Fenders

These handcrafted carbon fiber fenders simply replace the stock plastic fenders for an aggressive look and weight savings.

a. Front Fender

**2S3-F15E0-V0-00** \$418.95

b. Rear Fender

**2S3-F15E0-U0-00** \$599.95

10



### 12. Carbon Fiber Side Cover Set

These handcrafted carbon fiber side covers simply replace the stock side covers for an aggressive look around the engine plus weight savings.

**2S3-F17B0-V0-00** \$529.95

11a



11b



### 13. Carbon Fiber Top Cover

This handcrafted carbon fiber top cover replaces the stock painted top cover and makes an aggressive performance statement.

**2S3-F41G0-V0-00** \$499.95

12



13



14



### 14. Carbon Fiber Meter Cover

Handcrafted carbon fiber meter cover replaces the stock aluminum cover to complete the aggressive carbon fiber look of the top cover.

**2S3-H35B0-V0-00** \$222.95



These accessories fit '09~'10 VMAX models unless otherwise noted.

### 1. Touring Windshield

Made of tough 4.5mm clear polycarbonate and treated with the new generation Quantum™ Coating to provide a long lasting, durable, protective finish. Includes brushed aluminum accents. The 15-1/2" high\*\* windshield helps provide wind protection for the upper torso and head area. Mounting hardware included.

**2S3-F83J0-U0-00**      \$359.95

### 2. Boulevard™ Windscreen

This dark-tinted, polycarbonate windscreen is treated with the new generation Quantum™ Coating and comes with brushed aluminum accents. It provides enough protection to keep the wind off of your chest and enough attitude to turn heads.

**2S3-F83J0-V0-00**      \$259.95

### 3. NEW! VMAX Wide Wheel

Want to mount a little more meat on your Monster? High-quality, die cast wheel is the same design as the stock wheel with one exception; it allows for the fit-up of a 240 tire\*. Wheel requires Wide Wheel Bearing Kit (2S3-F53S2-V0-00), sold separately. Bearing Kit includes bearings, seals, O-Ring, collar, screws, and valve stem for a complete installation.

**2S3-F53S0-V0-00**      \$769.95

Wide Wheel Bearing Kit

**2S3-F53S2-V0-00**      \$75.95

*For closed-course use only - requires permanent removal of inner swing arm inspection plate, necessitating frequent cleaning of drive shaft area. \*240/40-18 Metzeler ME880 Marathon tire recommended.*

### 4. VMAX Motorcycle Cover

This unique and versatile cover accommodates a fully accessorized VMAX while maintaining a custom-fit look. Made of durable, yet soft cotton canvas for protection against exhaust pipe heat. Features the VMAX logo and contrasting red piping. (Not recommended for trailering.)

Black

**2S3-F81A0-V0-00**      \$149.95

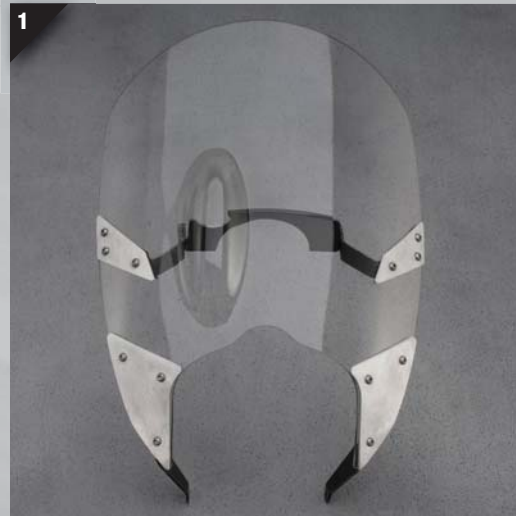

These accessories fit '09~'10 VMAX models unless otherwise noted.  
\*\*Height measure from top of headlight cutout to top of windshield.

**Warrior® Accessories****Comfort Cruise™  
Seats**

Comfort Cruise seats offer a new dimension of riding comfort. Whether you're going across town or across the country, Star Custom Accessories has a seat that is just right for your riding style.

Features include:

- Traditional styling and quality that you have come to expect from all Star Custom Accessories
- Luxurious real leather seating panels
- Hand-laid fiberglass seat pan for consistent fit
- Soft foam edges for added comfort and protection for painted surfaces
- Soft foam nose for a close fit to the tank
- Custom foam formulation for a "soft-to-touch" feel, along with firmness and support for an all-day ride

**Stiletto****1. Plain**

Fits '04~'09 Warrior

**STR-5PX22-31-H0** \$374.95

Fits '02~'03 Warrior

**STR-5PX22-30-H0** \$374.95

**2. Alligator (faux)**

Fits '04~'09 Warrior

**STR-5PX22-31-H8** \$374.95

Fits '02~'03 Warrior

**STR-5PX22-30-H8** \$374.95

**Boulevard™****3. Plain**

Fits '04~'09 Warrior

**STR-5PX24-11-H0** \$289.95

Fits '02~'03 Warrior

**STR-5PX24-10-H0** \$267.95

**4. Ostrich (faux)**

Fits '02~'03 Warrior

**STR-5PX24-10-H7** \$267.95

Alligator (faux)

(Not shown)

Fits '04~'09 Warrior

**STR-5PX24-11-H8** \$289.95



These accessories fit all Warrior models unless otherwise noted.

## Comfort Cruise™ Pillion Pad

The Comfort Cruise™ Pillion Pad offers a new dimension of passenger comfort. Designed to coordinate with Boulevard Comfort Cruise Solo Seat to give your bike the right look, with a comfortable feel your passenger will appreciate.

### 1. Boulevard

a. Plain

Fits '04~'09 Warrior  
**STR-5PX25-41-H0** \$236.95

Fits '02~'03 Warrior  
**STR-5PX25-40-H0** \$236.95

b. Ostrich (faux)

Fits '02~'03 Warrior  
**STR-5PX25-40-H7** \$236.95

Alligator (faux)

(Not shown)  
Fits '04~'09 Warrior  
**STR-5PX25-41-H8** \$236.95

### 2. Mini Tank Cover

This soft leather mini cover simply attaches to the fuel tank. Looks good and helps protect the paint from pant leg wear.

Plain  
**STR-5PX49-50-00** \$53.95

### 3. Cruiselite® Saddlebag System

These great looking and functional bags are constructed from tough 1000D Cordura® nylon with built-in polyethylene reinforcements to hold their shape even when empty. This Cruiselite® luggage system provides up to 2500 cubic inches of storage. System includes saddlebags and detachable duffel bag with shoulder strap. No additional mounting hardware required. Duffel bag is 17" L x 10" H x 8" W. The saddlebags are 19" L x 8" H (max.) x 4" W.

**STR-5PX73-70-00** \$203.95

### 4. Expandable Tank Bag

Made of tough, water-resistant ballistics nylon. Provides 550 cubic inches of convenient storage for small items and short day trips and quickly expands to over 900 cubic inches when you need the extra room. Features include an embroidered Star logo, five interior pockets, and reversible water-proof map pocket. For carry-away convenience, bag attaches to tank with special high-strength magnets that are shielded to help protect electronic devices you may be carrying. (11" L x 13" W x 4" H or 7-1/2" expanded)

**STR-4WM64-21-00** \$96.95

### 5a. Mink Oil

Use to waterproof, preserve, and protect your leather accessories.

4-oz. Jar  
**ACC-MINKC-RE-AM** \$2.95

### 5b. Saddle Soap

Use to clean, condition, and restore your leather accessories.

4-oz. Jar  
**ACC-SADDL-ES-AP** \$2.95

### 5c. Black Leather Polish

Use to restore black leather to its natural luster by putting color back into the leather.

1.5-oz. Jar  
**ACC-CREAM-PL-SH** \$2.49



Warrior shown with Star Custom Accessories and custom paint.

## 6. Billet Mirrors

Our stylish mirrors are designed to fit the Warrior's aggressive personality and provide excellent visibility. Available in two head shapes with three finishes to complement many other Warrior accessories. Smooth and Brushed styles have holes in stem. Left and right hand mirrors sold separately.

### Oval

Ball Milled, Left

**STR-5PX13-31-00** \$129.95

Ball Milled, Right

**STR-5PX13-32-00** \$129.95

Smooth, Left

**STR-5PX13-41-00** \$129.95

Smooth, Right

**STR-5PX13-42-00** \$129.95

Brushed, Left

**STR-5PX13-61-00** \$129.95

Brushed, Right

**STR-5PX13-62-00** \$129.95

### Tear Drop

Ball Milled, Left

**STR-5PX13-11-00** \$129.95

Ball Milled, Right

**STR-5PX13-12-00** \$129.95

Brushed, Left

**STR-5PX13-51-00** \$129.95

Brushed, Right

**STR-5PX13-52-00** \$129.95

## 7. Billet Shift Linkage

Replaces the stock shift linkage. Machined billet aluminum finished to coordinate with other billet Warrior accessories.

Ball Milled

**STR-5PX27-67-02** \$55.95

Brushed (with holes)

**STR-5PX27-67-07** \$62.95

Smooth (with holes)

**STR-5PX27-67-08** \$62.95

## 8. Billet Single Arm Shift Lever

Replaces the stock shift lever for added style and finished to coordinate with many other Warrior accessories.

Ball Milled

**STR-5PX38-00-02** \$118.95

Brushed (with holes)

**STR-5PX38-00-07** \$118.95

Smooth (with holes)

**STR-5PX38-00-08** \$118.95

Replacement Rubber Inserts

**STR-5PX36-10-98** \$17.95

## 9. Billet Rear Brake Pedal Assembly

Designed to replace the stock brake pedal assembly. This machined billet piece includes brake pedal with replaceable rubber inserts, with finishes to coordinate with other Warrior accessories.

Ball Milled

**STR-5PX39-10-02** \$150.95

Brushed (with holes)

**STR-5PX39-10-07** \$150.95

Smooth (with holes)

**STR-5PX39-10-08** \$150.95

Replacement Rubber Pads

**STR-5PX36-10-98** \$17.95



These accessories fit all Warrior models unless otherwise noted.

### 1. Mini Rider Floorboards with Rubber Inserts

These mini floorboards mount to existing foot pegs, replacing the stock rubber, to add style and comfort. (Sold in pairs.)

Chrome  
**STR-5PX27-11-01** \$193.95

### 2. Billet Rider Foot Pegs

Billet foot pegs that coordinate with accessory billet brake pedal, shifter and passenger pegs. Pegs include unique rubber inserts. (Sold in pairs.)

Smooth  
**STR-5PX36-70-01** \$134.95

Replacement Rubber Inserts  
(Order two if replacing rubber on both pegs.)

**STR-5PX36-70-98** \$17.95

### 3. Billet Passenger Foot Pegs with Rubber Inserts

Replace the stock "road-race" style passenger pegs with these stylish and functional passenger foot pegs. Pegs include unique rubber inserts. (Sold in pairs.)

Chrome  
**STR-5PX36-10-01** \$96.95

Replacement Rubber Inserts  
(Order two if replacing rubber on both pegs.)

**STR-5PX36-10-98** \$17.95

### 4. Chrome Passenger Foot Pegs with Rubber Inserts

Chrome-plated foot pegs designed to replace stock passenger pegs. All necessary hardware included for easy installation and proper fit. (Sold in pairs.)

**STR-5BN36-20-03** \$65.95

### 5. Passenger Foot Peg Relocation Kit

Kit relocates passenger foot pegs forward and down, while maintaining foot clearance with the stock muffler. (Foot pegs sold separately.)

**STR-5PX57-40-00** \$65.95







### 6. Billet Drive Pulley Covers

Machined from billet aluminum in finishes to coordinate with other Warrior accessories.

Smooth	
<b>STR-5PX27-81-01</b>	\$93.95
Ball Milled	
<b>STR-5PX27-81-02</b>	\$98.95
Brushed	
<b>STR-5PX27-81-07</b>	\$93.95



### 7. Billet Drive Pulley Case Set

Precision-machined from billet aluminum to give your Warrior a show-worthy appearance. This case set replaces the existing front pulley cover, leaving the pulley with its machined billet cover visible. Kit includes stainless steel hardware.

Fits '02~'05 Warrior	
Smooth	
<b>STR-5PX27-82-01</b>	\$310.95
Ball Milled	
<b>STR-5PX27-82-02</b>	\$310.95
Brushed	
<b>STR-5PX27-82-07</b>	\$310.95



### 8. Billet Drive Covers

Machined from billet aluminum, then polished and finished to coordinate with other billet Warrior accessories.

Ball Milled	
<b>STR-4WM27-83-02</b>	\$193.95
Flamed	
<b>STR-4WM27-83-03</b>	\$193.95
Brushed	
<b>STR-4WM27-83-07</b>	\$213.95

### 9. Billet Swingarm Pivot Covers

Replace the stock plastic covers with these billet-aluminum pieces. Simple push-in design.

a. Smooth	
<b>STR-5PX27-57-01</b>	\$45.95
b. Brushed	
<b>STR-5PX27-57-07</b>	\$53.95



These accessories fit all Warrior models unless otherwise noted.

### 1. Speedstar® Air Cleaner Assembly

Replace the stock air cleaner with this race inspired Speedstar air cleaner. All hardware included for easy installation.

Chrome (Shown)

**STR-5PX09-57-01** \$182.95

Onyx

**STR-5PX09-57-YB** \$193.95

Replacement Filter Element

**5PX-14461-00-00** \$15.97

### 2. Speedstar® AIS Cover

Replace the stock AIS cover with this Speedstar-inspired cover. Sleek new design coordinates with Speedstar Air Cleaner.

Chrome (Shown)

**STR-5PX09-67-01** \$182.95

Onyx

**STR-5PX09-67-YB** \$193.95

### 3. Billet Pushrod Tube Covers

These covers add to the massive motor look. Machined from aircraft-quality aluminum and finished to coordinate with other Warrior accessories. Unique clip-on design allows for easy, yet secure installation.

(Sold in pairs.)

Ball Milled

**STR-5PX27-45-02** \$88.95

Brushed

**STR-5PX27-45-07** \$101.95

### 4. Billet Frame Inserts

These inserts attach next to the steering head using a high-strength adhesive backing for a clean, custom look. Precision machined and finished to coordinate with other Warrior accessories.

Smooth

**STR-5PX27-58-01** \$89.95

Ball Milled

**STR-5PX27-58-02** \$96.95

Brushed

**STR-5PX27-58-07** \$89.95

### 5. Billet Clutch Cover Insert

Machined from billet aluminum, then polished and finished to coordinate with other billet Warrior accessories.

Smooth

**STR-5PX27-43-01** \$102.95

Ball Milled

**STR-5PX27-43-02** \$102.95

Brushed

**STR-5PX27-43-07** \$102.95

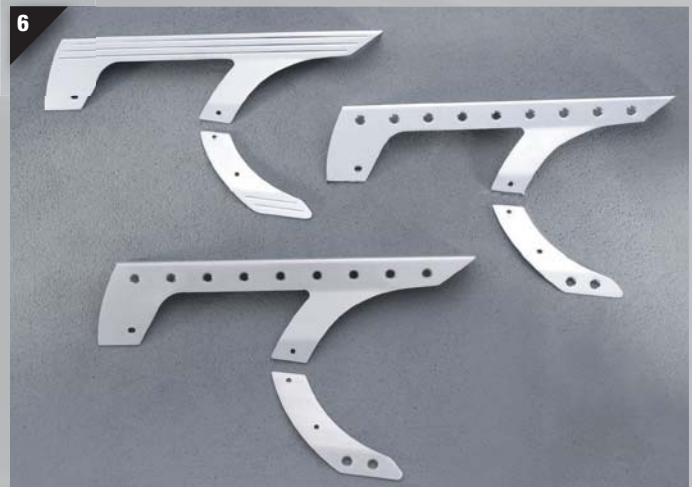

### 6. Aluminum Upper Belt Guard

High-quality 6061-T6 aluminum plate is formed, machined, and finished to coordinate with other Warrior accessories. Includes the upper belt guard and a matched lower guard accent.

Smooth (with holes)

**STR-5PX85-10-08** \$99.95

Ball Milled

**STR-5PX85-10-02** \$96.95

Brushed (with holes)

**STR-5PX85-10-07** \$96.95

### 7. Chrome Upper Belt Guard

Stock guard, highly polished and chrome-plated. Upper belt guard and lower accent.

**STR-5PX85-10-01** \$70.95



### 8. Billet Fork Tube Covers

Get the great look of high-tech, high-dollar forks without sacrificing handling with these machined aluminum upper fork covers. (Sold in pairs.)

Fits '02~'05 Warrior

Smooth

**STR-5PX27-93-01** \$193.95

Ball Milled

**STR-5PX27-93-02** \$199.95

Brushed

**STR-5PX27-93-07** \$214.95

### 9. Billet Fork Cap Covers

Precision machined and finished to coordinate with other Warrior accessories. (Sold in pairs.)

Smooth

**STR-5PX27-02-01** \$45.95

Ball Milled

**STR-5PX27-02-02** \$48.95

Brushed

**STR-5PX27-02-07** \$53.95



Warrior shown with Star Custom Accessories and custom paint.



**1. Billet Fork Stem Nut Cover**

Precision machined and finished to coordinate with other Warrior accessories.

Smooth

**STR-5PX27-06-01**     \$24.95

Brushed

**STR-5PX27-06-07**     \$28.95



**2. Billet Front Axle Bolt Covers**

Precision machined and finished to coordinate with other Warrior accessories. (Sold in pairs.)

Ball Milled

**STR-5PX27-04-02**     \$41.95



**3. Billet Rear Axle Bolt Covers**

Precision machined and finished to coordinate with other Warrior accessories. (Sold in pairs.)

Smooth

**STR-5PX27-05-01**     \$41.95

Ball Milled

**STR-5PX27-05-02**     \$44.95

Brushed

**STR-5PX27-05-07**     \$47.95



**4. Billet Head Bolt Covers**

Unique push-on design covers visible bolt for a clean finish. (Sold in pairs.)

**STR-4WM27-37-01**     \$22.95

**5. Billet Rectifier Cover**

Billet aluminum cover simply attaches over the stock rectifier for a clean finish.

Smooth

**STR-5PX27-68-01**     \$86.95

Brushed

**STR-5PX27-68-07**     \$86.95



**6. Billet Cam Cover**

Sleek, precision-machined billet cover replaces stock two-piece design for a full custom look. Requires installation of Billet Compression Release Cover (sold separately).

Smooth with "102 cu. in." logo  
**STR-5PX27-36-01** \$88.95

Ball Milled

**STR-5PX27-36-02** \$88.95

Brushed with "102 cu. in." logo

**STR-5PX27-36-07** \$91.95

**7. Billet Compression Release Cover**

Designed to replace stock cover and coordinate with Billet Cam Cover (required for installation). Not compatible with Speedstar Exhaust System.

Smooth  
**STR-5PX27-76-01** \$59.95

Brushed

**STR-5PX27-76-07** \$59.95

**8. Billet Cam Cover Insert**

Precision machined, polished, and chrome-plated cover simply replaces stock cover to coordinate with other billet Warrior accessories.

Ball Milled

**STR-4WM27-41-02** \$52.95

Brushed

**STR-5PX27-41-07** \$62.95

**9. Billet Alternator Cover**

Precision machined and custom finished to coordinate with other billet Warrior accessories. This cover simply replaces stock cover.

Smooth

**STR-5PX27-44-01** \$48.95

Ball Milled

**STR-4WM27-44-02** \$48.95

Brushed

**STR-5PX27-44-07** \$48.95

**10. Billet Generator Access Cover**

Custom-finished billet cover simply replaces stock cover for a custom look. Coordinates with other Warrior accessories.

Smooth

**STR-4WM27-47-01** \$29.95

Brushed

**STR-4WM27-47-07** \$29.95

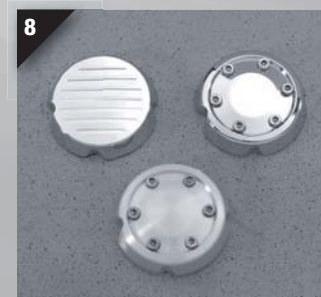

### 1. Billet Starter End Cap Cover

Simple bolt-on design covers the existing starter end cap for a clean finish. Coordinates with other Warrior accessories.

Smooth

**STR-5PX27-46-01** \$65.95

Brushed

**STR-5PX27-46-07** \$70.95



### 2. Billet Spark Plug End Covers

These machine billet pieces fit over the stock spark plug caps. (Sold in pairs.)

Ball Milled

**STR-4WM27-65-02** \$52.95



### 3. Billet Oil Filter Cover

Simple design covers stock oil filter for a detailed appearance. Requires removal of oil filter for installation.

**STR-4WM27-49-02** \$69.95



### 4. Billet Wire Harness Guides

Replace the nylon cable ties with these chrome guides. (Sold in pairs.)

**STR-4NK27-62-01** \$70.95

## 5. Billet License Plate Frame

Compact billet license frame kit includes all hardware and backing plate.

Smooth

**STR-5PX27-01-01** \$81.95

Brushed

**STR-5PX27-01-07** \$83.95



## 6. Custom License Frames

These custom frames are available in two finishes. Smooth style features a 1/2" round molded edge with a clear license cover and chrome backing plate. Ball milled style features chrome plated billet aluminum construction with Star logo and chrome backing plate. Chrome mounting hardware is included with both styles.

Smooth

**STR-4NK26-25-00** \$59.95

Ball Milled

**STR-4NK27-01-03** \$96.95



## 7. Inner Fender Eliminator Kit

This kit eliminates the inner fender and relocates the license plate and reflectors for a clean, custom look. Use with any of the Star accessory license plate frames (sold separately) for an exceptional appearance.

**STR-5PX82-00-00** \$69.95



## 8. Chrome Fender Stays

Stock fender stays are carefully polished and chrome-plated to a show finish.

**STR-5PX81-10-00** \$214.95

## 9. Chrome Master Cylinder Cover

Attach to the master cylinder reservoir for a personalized, highly polished, chrome-plated look.

**STR-4WM18-10-01** \$22.95

## 10. Chrome Pulley Nut Covers

These chrome-plated polymer caps simply press on over the stock pulley nuts without having to remove the wheel. (Set of five.)

**STR-4WM26-08-17** \$16.95

## 11. Chrome Allen Bolt Plugs

Nickel-chrome-plated plugs are available in three sizes to fit most of the Allen bolts found on all Star models.

5mm (Box of 20)

**STR-4NK26-01-20** \$12.95

6mm (Box of 10)

**STR-4NK26-02-10** \$7.95

8mm (Box of 10)

**STR-4NK26-03-10** \$7.95



Warrior shown with Star Custom Accessories and custom paint.



### 1. Billet Handlebar Riser—Medium Rise

CNC-machined risers and upper clamp provide 2-1/4" rise and 1-1/4" pullback over stock risers.

Smooth

**STR-5PX75-70-01** \$193.95

Brushed

**STR-5PX75-70-07** \$203.95

NOTE:

Depending on the positioning of these handlebars and components, custom extended-length cables and hoses may be required.



### 2. Billet Handlebar Risers—Stock Height

Stock handlebar position with a bold look. Kit includes machined billet risers and upper clamp either with ball-milled lines or CNC-machined Warrior logo. (Sold in pairs.)

Ball Milled

**STR-5PX75-60-02** \$177.95

Smooth

**STR-5PX75-60-05** \$177.95

Brushed

**STR-5PX75-60-07** \$182.95

### 3. Warrior Bend Handlebars

Wider, lower positioning than stock. Comfortable bend designed to work with either stock risers or our stock-height Billet Handlebar Risers, while retaining stock cable and hose lengths. Bars have 2-7/8" rise, 12-3/8" pullback, and 30-1/8" width.

**STR-5PX75-13-00** \$86.95



### Billet Handlebar Risers—Tall Rise and Flat Bar

Designed for the custom drag-bike look, these billet risers and flat bar replace the stock bars and risers.

Available in finishes to coordinate with other Warrior accessories.

When used as set, bars have 6-1/2" rise, 10-1/4" pullback, and 23-3/4" width).

### 4. Handlebar Risers

Smooth

**STR-5PX75-50-08** \$214.95

### 5. Flat Bar

**STR-5PX75-14-00** \$69.95

### 6. Fat Double "T" Bars

Drag bike styling with a highly polished and chrome-plated finish. Bars have 6-1/2" rise, 10-1/2" pullback, and 34-1/4" width.

**STR-5PX75-12-00** \$160.95

### 7. Billet Handlebar Clamp

Precisely machined and specially treated for a highly polished chrome or a brushed finish. Features Star logo.

Brushed

**STR-4NK27-17-07** \$70.95





## 8. Chrome Grips

These custom grips include rubber ribs for styling and grip. Attractive and easy to install. (Sold in pairs.)

**STR-4NK37-10-11** \$59.95

## 9. Braided Stainless Steel Cables

Upgrade the appearance of your Star cruiser by replacing the stock black cables with these stainless steel braided cables built to exacting stock specifications. Nylon inner liner for smooth operation. Cable has a rugged clear coat on its full length to make it easier to clean, while helping to protect windshields and painted surfaces. (Dealer installation recommended.)

Throttle Cable Set

**STR-5PX48-10-SD** \$86.95

Clutch Cable

**STR-5PX48-20-SD** \$49.95

## 10. Braided Stainless Steel Brake Lines

All of our hydraulic lines are constructed using 308 stainless steel braided brake hose with a Teflon® inner liner. Brake line has a rugged clear coat on its full length to make it easier to clean, while helping to protect windshields and painted surfaces. (Dealer installation recommended.)

Front

**STR-5PX48-30-SD** \$160.95

Rear

**STR-5PX48-50-SD** \$75.95

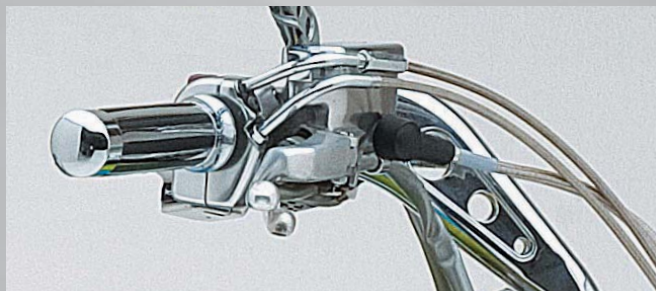

## 11. Tachometer Cowl

Cover your tachometer with this tough injection molded ABS cowl. Color coordinated to match stock components with the fit and finish you have come to expect from Star Custom Accessories.

Metallic Titanium ('02 model)

**STR-5PX04-10-MT** \$129.95

Imperial Red ('02 model)

**STR-5PX04-10-IR** \$129.95

Liquid Silver ('03 and '09 models)

**STR-5PX04-10-LS** \$129.95

Onyx ('03, '05~'09 models) (Shown)

**STR-5PX04-10-YB** \$129.95

Indigo ('02 and '04 models)

**STR-5PX04-10-IN** \$129.95

Cerulean Silver ('04 model)

**STR-5PX04-10-CS** \$129.95

Black Cherry ('05 model)

**STR-5PX04-10-BC** \$129.95

Candy Red ('08 model)

**STR-5PX04-10-CR** \$129.95

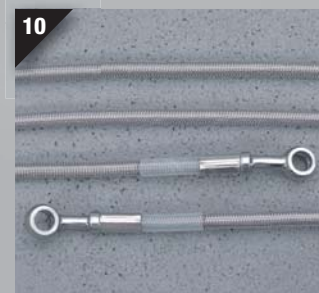

Warrior shown with Star Custom Accessories and custom paint.

## 1. Mini Fairing

This aerodynamically designed mini fairing is constructed of molded plastic and painted to coordinate with the stock components to provide the fit and finish you have come to expect from Star Custom Accessories. Mounting hardware included for easy installation.

Metallic Titanium ('02 model)	
<b>STR-5PX04-00-MT</b>	\$374.95
Imperial Red ('02 model)	
<b>STR-5PX04-00-IR</b>	\$374.95
Indigo ('02 and '04 models)	
<b>STR-5PX04-00-IN</b>	\$374.95
Liquid Silver ('03 and '09 models)	
<b>STR-5PX04-00-LS</b>	\$374.95
Onyx ('03, '05~'09 models) (Shown)	
<b>STR-5PX04-00-YB</b>	\$374.95
Cerulean Silver ('04 model)	
<b>STR-5PX04-00-CS</b>	\$374.95
Black Cherry ('05 model)	
<b>STR-5PX04-00-BC</b>	\$374.95
Candy Red ('08 model)	
<b>STR-5PX04-00-CR</b>	\$374.95

Replacement Windscreen	
<b>STR-5PX04-02-30</b>	\$101.95

## 2. Lower Cowl

Molded plastic construction provides a sleek performance look. Color coordinated to match stock components with the fit and finish you have come to expect from Star Custom Accessories. Mounting hardware included for easy installation.

Metallic Titanium ('02 model)	
<b>STR-5PX08-00-MT</b>	\$246.95
Imperial Red ('02 model)	
<b>STR-5PX08-00-IR</b>	\$246.95
Indigo ('02 and '04 models)	
<b>STR-5PX08-00-IN</b>	\$246.95
Liquid Silver ('03 and '09 models)	
<b>STR-5PX08-00-LS</b>	\$246.95
Onyx ('03, '05~'09 models) (shown)	
<b>STR-5PX08-00-YB</b>	\$246.95
Cerulean Silver ('04 model)	
<b>STR-5PX08-00-CS</b>	\$246.95
Black Cherry ('05 model)	
<b>STR-5PX08-00-BC</b>	\$246.95
Candy Red ('08 model)	
<b>STR-5PX08-00-CR</b>	\$246.95



### Star Custom Accessory Windshields

Our tough 4.5mm-thick polycarbonate windshields not only offer the superior fit and finish you would expect, we went a step further by treating them with the new-generation Quantum™ Coating to provide a long lasting, durable, protective finish. This makes the windscreen three times more scratch-resistant than typical acrylic products, and also much more resistant to damage from bugs, stone chips, road grime, or even everyday cleaning. This extra attention to detail will help keep your windshield looking new longer, and that's a clear benefit you'll enjoy on every ride.

#### 3. Boulevard™ Windshield

11" tall\*\*. Includes triple-plated mounting hardware.

Smooth

**STR-5PX05-00-31** \$182.95

Ball Milled

**STR-5PX05-00-32** \$182.95

Brushed

**STR-5PX05-00-37** \$182.95

#### 4. Warrior Cover

Versatile cover made of urethane-coated, weather-resistant polyester to protect your investment from the elements. Cover includes a canvas heat shield and handy storage bag. Even accommodates accessories. (Not recommended for trailering.)

**STR-5PXCUCU-SC-VR** \$123.95

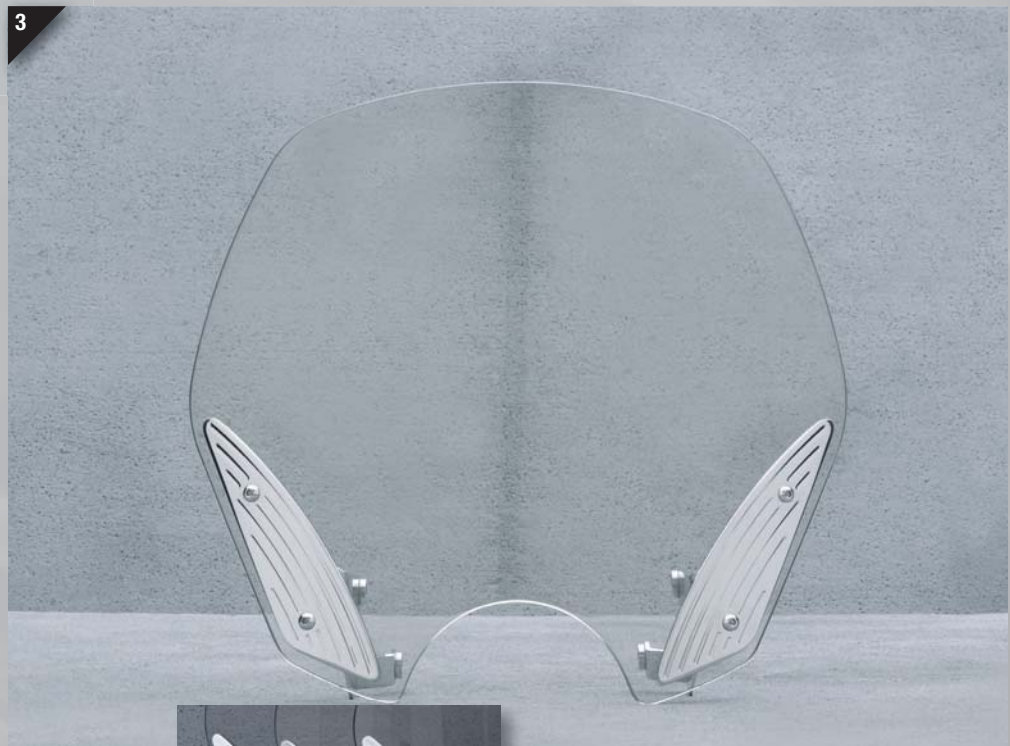

These accessories fit all Warrior models unless otherwise noted.

\*\*Height measured from the top of headlight cutout to top of windshield.

**Road Star® Accessories**

**Comfort Cruise™ Seats**

Comfort Cruise™ seats offer exceptional riding comfort. Whether you're going across town or across the country, Star Custom Accessories has a seat that is just right for your riding style.

Features include:

- Traditional styling and quality that you have come to expect from all Star Custom Accessories
- Luxurious real leather seating panels
- Hand-laid fiberglass seat pan for consistent fit
- Soft foam edges for added comfort and protection for painted surfaces
- Soft foam nose for a close fit to the tank
- A "soft to-touch" feel along with firmness and support for an all-day ride



**1. Stiletto**

Plain  
**STR-4WM22-30-H0** \$321.95

**2. Solo**

a. Plain  
**STR-4WM24-10-H0** \$374.95  
b. Studded with Skirt and Conchos  
**STR-4WM24-10-H4** \$374.95

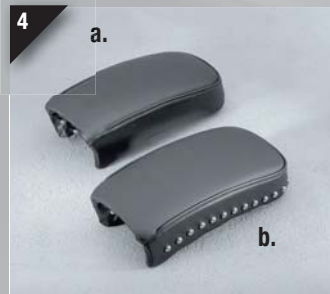

**3. Boulevard™**

Ostrich (faux)  
**STR-4WM24-10-H7** \$267.95



**Comfort Cruise™ Pillion Pads**

Comfort Cruise™ pillion pads offer a new dimension of passenger comfort. Designed to coordinate with Comfort Cruise Solo Seats to give your bike the right look, with a comfortable feel your passenger will appreciate.

**4. Long**

a. Plain  
**STR-4WM25-20-H0** \$236.95  
b. Studded  
**STR-4WM25-20-H2** \$236.95

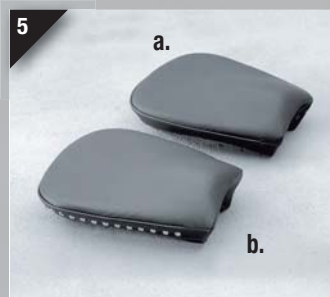

**5. Tour**

a. Plain  
**STR-4WM25-30-H0** \$321.95  
b. Studded  
**STR-4WM25-30-H2** \$321.95

**6. Boulevard™**

Ostrich (faux)  
**STR-4WM25-40-H7** \$236.95

## 7. Quick-Release Backrest Sidearms

Lockable, two-piece, quick-release system provides an easy-on, easy-off solution to passenger comfort. Polished and chrome plated uprights are sold separately and available in Short (same as standard Silverado) and Tall (+3") heights. Compatible with Deluxe and Custom backrest pads (sold separately).

**STR-5VN41-10-00** \$245.95

## 8. Quick-Release Backrest Uprights

These polished and chrome plated uprights are sold separately and available in Short (same as standard Silverado) and Tall (+3") heights. Uprights designed for use in conjunction with Quick Release Backrest Sidearms and are compatible with Deluxe and Custom backrest pads (all components sold separately).

a. Short

**STR-5VN41-30-01** \$114.95

b. Tall

**STR-5VN41-30-02** \$123.95

## 9. Passenger Backrest Components

A three-piece system with triple-chrome plating. The upright is 3-inches taller than the standard Silverado® backrest and angled slightly forward to complement the standard seat. Backrest pad is constructed of sturdy vinyl and designed to coordinate with stock Road Star seats.

a. Deluxe Backrest Upright

Tall

**STR-5GA41-30-02** \$155.95

b. Deluxe Backrest Sidearms

**STR-5GA41-10-00** \$182.95

c. Deluxe Backrest Pad

Plain

**STR-5GA41-50-01** \$59.95

## 10. Custom Backrest Pad

Plain (Shown)

**STR-5GA41-50-00** \$107.95

Studded

**STR-5GA41-50-02** \$107.95

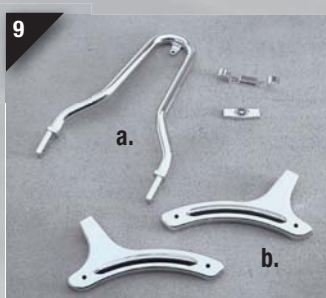

These accessories fit all Road Star models unless otherwise noted.

## 1. Road Star Hard Saddlebags

These injected-molded, high-impact ABS saddlebags are designed to complement the smooth lines of the Road Star. With over 3200 cubic inches of combined storage, they are more than just good lookers.

Available painted to coordinate with stock models, or unpainted ready for your custom paint. Installation requires either existing Silverado saddlebag mounts or accessory mounting hardware (STR-5GA73-40-00) sold separately. (14" H x 25-1/2" L x 11" W)

Primer (all models)

**STR-4WM72-00-00** \$929.95

Onyx ('99~'03 and '05 models)

**STR-4WM72-00-YB** \$1,029.95

Deep Mocha ('03 model)

**STR-4WM72-00-DM** \$1,029.95

Charcoal Blue ('03 model)

**STR-4WM72-00-CB** \$1,029.95

Graphite Gray ('03 model)

**STR-4WM72-00-GG** \$1,029.95

Beach Sand Tan ('04 model)

**STR-4WM72-00-BS** \$1,029.95

Raspberry Metallic ('04 model)

**STR-4WM72-00-RM** \$1,029.95

Raven ('04~'07, '09~'10 models)

**STR-4WM72-00-RA** \$1,029.95

Liquid Silver ('04~'07 models)

**STR-4WM72-00-LS** \$1,029.95

Pearl White ('04, '06, '08 and '10 models)

**STR-4WM72-00-NW** \$1,029.95

Black Cherry ('05 model)

**STR-4WM72-00-BC** \$1,029.95

Charcoal Silver ('08 model)

**STR-4WM72-00-DS** \$1,029.95

Cobalt Blue ('08 model)

**STR-4WM72-00-BL** \$1,029.95

Candy Red ('09~'10 models)

**STR-4WM72-00-CR** \$1,029.95

Gray Metallic ('09 model)

**STR-4WM72-00-LG** \$1,029.95

## 2. Hard Saddlebag Liners

Constructed of heavy-duty ballistic nylon for added durability, these saddlebag liners provide carry-away convenience for your luggage. Also features an embroidered Star logo for a quality look and feel. (Sold in pairs.)

**STR-4WM72-90-00** \$86.95

## 3. Silverado® Saddlebags

The distinctive design uses handcrafted, quality leather with an internal frame to hold the bag's shape when empty. The studded bags are the same as those used on the Silverado model. Plain style bags feature an embossed Star logo, and coordinate with either the stock Road Star or the plain custom seats. Generous 11" H x 21" L x 7-1/2" W size.

Plain

**STR-5VN73-00-00** \$787.95

Studded

**STR-5VN73-02-00** \$787.95

Mounting Hardware

**STR-5GA73-40-00** \$174.95

## 4. Special Edition Saddlebags

From our Special Edition collection! These bags are based on our popular Silverado saddlebags with unique touches like leather whipstitch trim and quick-release Special Edition buckles. Combine with the Special Edition Tank Panel and Windshield Panel (shown on page 8-42) to have a truly unique Special Edition look.

**STR-5GA73-00-SE** \$825.95

Mounting Hardware  
(Not shown)

**STR-5GA73-40-00** \$174.95



## 5. Tour Classic® Saddlebags

A distinctive design, handcrafted quality leather, and an internal frame that holds the saddlebag's shape when empty. Includes a zippered pouch in the lid to separate your small personal items. (12" H x 20" L x 8" W)

Plain

**STR-4NL73-01-00** \$849.95

Studded

**STR-4NL73-02-00** \$878.95

Mounting Hardware

(Not shown)

**STR-4WM73-40-10** \$189.95

Saddlebag Rain Covers

(Not shown)

**STR-4NL73-80-00** \$32.95

5



6



## 6. Tour Classic® Trunk

High-quality, handcrafted leather is used to create this classic looking, ruggedly designed trunk. Internal frame holds the trunk's shape even when empty. The main compartment is a generous 12" x 13" x 7" size with three handy external storage compartments. Requires rear luggage rack.

Studded

**STR-4NK49-23-00** \$460.95

7



## 7. Cruiselite® Classic Saddlebags

These handcrafted, throw-over design bags of a premium synthetic material feature a metal frame, plastic base insert and a hard rubber back to help hold the bag's shape when empty. Saddlebag Support Bars (sold separately) required for installation. (10" x 12" x 4-1/2")

Plain

**STR-5KS73-50-00** \$259.95

Studded

**STR-5KS73-50-02** \$269.95

## Throw-Over Saddlebags

These handcrafted, throw-over design leather bags feature a plastic base insert and a hard rubber back to help hold the bag's shape when empty. Interior pockets and zippered pouch included. Saddlebag Support Bars (sold separately) required for installation.

### 1. Star Slant Saddlebags

(10" x 15-1/2" x 5")

Plain

**STR-4NK73-10-00** \$369.95

Fringed

**STR-4NK73-10-01** \$407.95

Studded

**STR-4NK73-10-02** \$417.95

### 2. Classic Deluxe Saddlebags

(10" x 15-1/2" x 5")

Plain

**ABA-3JK73-00-02** \$343.95

Fringed

**ABA-3JK73-00-00** \$374.95

Studded

**ABA-3JK73-00-01** \$407.95

### 3. Classic Saddlebags

(10" x 12" x 4-1/2")

Plain

**ABA-3JK73-00-04** \$296.95

Fringed

**ABA-3JK73-00-05** \$343.95

Studded

**ABA-3JK73-00-03** \$343.95

### 4. Slant Saddlebags

(10" x 12" x 4-1/2")

Plain

**ABA-3JK73-00-06** \$321.95

Fringed

**ABA-3JK73-00-07** \$353.95

Studded

**ABA-3JK73-00-08** \$386.95





## 5. Leather Tool Bags

Handcrafted leather bags with Star Concho provides both function and style. Dual mounting straps, with double stitching at stress points. (10" x 5" x 3")

Plain

**STR-4NK46-11-00** \$53.95

Fringed

**STR-4NK46-12-00** \$65.95

Studded

**STR-4NK46-13-00** \$65.95



## 6. Leather Windshield Bags

These convenient bags are constructed of premium supple leather and include special mounting brackets designed to fit all Silverado and Road Star windshields. Twist closure makes access quick and easy.

Plain

**STR-4NK46-21-00** \$65.95

Studded

**STR-4NK46-23-00** \$65.95



## 7. Leather Backrest Bags

Handcrafted leather bags with Star Concho provide both function and style. Dual mounting straps, with double stitching at stress points. (6" H x 6" W x 4" D bottom and 2" top)

Plain

**STR-4NK47-11-00** \$75.95

Fringed

**STR-4NK47-12-00** \$79.95

Studded

**STR-4NK47-13-00** \$88.95

## 8. Expandable Tank Bag

Made of tough, water-resistant ballistics nylon. Provides 550 cubic inches of convenient storage, and then quickly expands to over 900 cubic inches when you need extra room. Embroidered Star logo, five interior pockets, and reversible waterproof map pocket. For carry-away convenience, bag attaches to tank with special high-strength magnets that are shielded to help protect electronic devices you may be carrying. (11" L x 13" W x 4" H or 7-1/2" expanded)

**STR-4WM64-21-00** \$96.95

## 9. Leather Tail Bag

This high-quality, all-leather bag is designed to attach quickly to our accessory rear fender rack to add over 300 cubic inches of storage. Includes a small zippered pouch on top. Built-in strap allows for easy carry-away. Foam integrated into the side panels helps the bag keep its shape even when empty. Coordinates with other Star leather products. (11" x 8" x 3")

Studded  
**STR-4WM63-10-01** \$214.95  
(Plain style shown not available)



### 1. Special Edition Tank Panel

Constructed of hand-selected leather, backed with suede leather to protect the paint and finished off with a handy pocket and whip-stitch trim.

Fits '99~'07 Road Star models  
**STR-5GA49-20-SE** \$113.95

### 2. Special Edition Windshield Panel

Hand-selected leather and whip-stitch trim will enhance any Road Star Silverado® windshield.

**STR-5GA07-59-SE** \$65.95

### 3. Narrow Tank Panel

Constructed of hand-selected leather, double-stitched at stress points and backed with suede leather to protect the paint.

Fits '08~'10 Road Star models  
Plain  
**STR-5VN49-20-00** \$72.95

Studded  
**STR-5VN49-20-01** \$88.95

Fits '99~'07 Road Star models  
Plain  
**STR-4WM49-20-00** \$67.95

Studded  
**STR-4WM49-20-01** \$74.95

### 4. Wide Tank Panel with Pocket

Constructed of hand-selected leather, double-stitched at stress points and backed with suede leather to protect the paint.

Fits '08~'10 Road Star models  
Plain  
**STR-5VN49-30-00** \$90.95

Studded  
**STR-5VN49-30-01** \$96.95

Fits '99~'07 Road Star models  
Plain  
**STR-4WM49-30-00** \$90.95

Studded  
**STR-4WM49-30-01** \$96.95

### 5. Tank Bra with Pocket

Constructed of hand-selected leather, double-stitched at stress points and backed with suede leather to protect the paint.

Fits '08~'10 Road Star models  
Plain  
**STR-5VN49-10-00** \$134.95

Studded  
**STR-5VN49-10-01** \$150.95

Fits '99~'07 Road Star models  
Plain  
**STR-4WM49-10-00** \$132.95

Studded  
**STR-4WM49-10-01** \$150.95

### 6. Mini Tank Cover

This soft leather mini cover simply attaches to the fuel tank. Looks good and helps protect the paint from pant leg wear.

Plain  
Fits '08~'10 Road Star models  
**STR-5VN49-50-00** \$53.95

Fits '99~'07 Road Star models  
**STR-4WM49-50-00** \$53.95

### 7. Star Conchos

Use these Star Conchos to personalize your apparel, bags, tank panels and more. (Sold in pairs.)

**STR-4NK78-10-00** \$22.95

### 8a. Mink Oil

Use to waterproof, preserve and protect your leather accessories.

4-oz. jar.  
**ACC-MINKC-RE-AM** \$2.95

### 8b. Saddle Soap

Use to clean, condition and restore your leather accessories.

4-oz. jar.  
**ACC-SADDL-ES-AP** \$2.95

### 8c. Black Leather Polish

Use to restore black leather to its natural luster by putting color back into the leather.

1.5-oz. jar.  
**ACC-CREAM-PL-SH** \$2.49

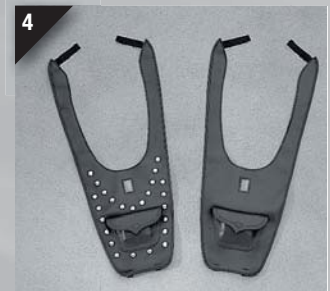

**JEFF PALHEGYI**  
**SIGNATURE SERIES -**  
**custom accessories from**  
**one of today's top bike**  
**builders**

Bike builder Jeff Palhegyi is the architect of many of the most admired customized Star motorcycles ever crafted. His creative work has appeared in top motorcycle shows and has been frequently featured in Custom Star calendars. Those lucky enough to own a motorcycle from Palhegyi Designs can count on attracting plenty of attention. Palhegyi's talent and creative vision have earned him recognition as one of the world's top custom bike designers. His artistry has been acknowledged in over 40 articles in national magazines, and he has made many TV appearances, including documentaries on SPEED TV ("V-Twin TV" and "Epic Rides"). Palhegyi customs have also been showcased in the IMS Tour in the United States, the Tokyo Motor Show in Japan, and the INTERMOT® and Milan shows in Europe.



**Custom "Bomber" Components**

Jeff Palhegyi has designed these custom Bomber-series chrome components exclusively for Star Motorcycles. Bomber covers are available either polished and plated to a show-quality chrome finish or in the "Midnight" collection for a blacked-out look detailed with brushed fin edges. Bomber components have a coordinated look to give your bike a true custom look.

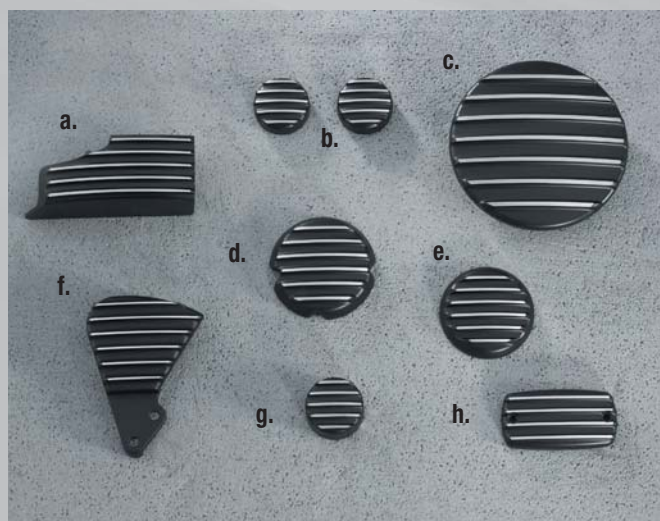

**Midnight Bomber Components**

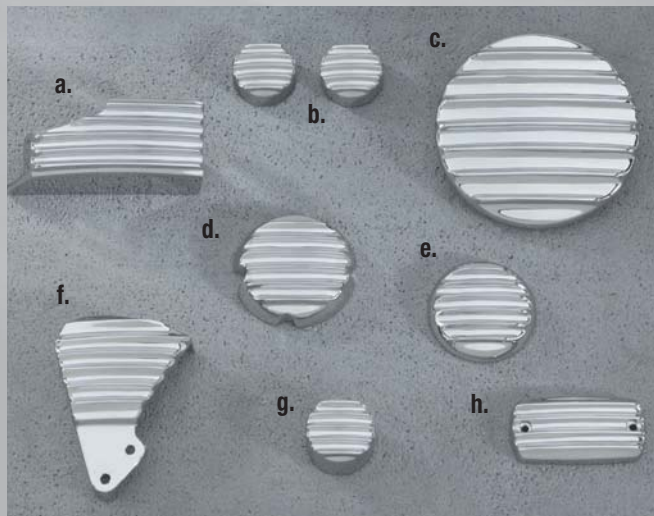

**Chrome Bomber Components**

**a. Rear Master Cylinder Cover**

This custom designed cover cleanly hides the rear master cylinder. Chrome hardware included for easy installation.

Fits '99-'07 Road Star models

Chrome  
**STR-5VN18-20-01** \$73.95

Midnight

**STR-5VN18-20-02** \$69.95

**b. Fork Cap Covers**

Clean up the upper clamp with these easy-to-install cap covers. (Sold in pairs.)

Chrome

**STR-5VN27-02-02** \$53.95

Midnight

**STR-5VN27-02-03** \$50.95

**c. Drive Pulley Cover Insert**

Replaces stock drive pulley cover insert.

Chrome

**STR-5VN27-81-02** \$99.95

Midnight

**STR-5VN27-81-03** \$97.95

**d. Cam Cover Insert**

Replaces stock cam cover insert.

Chrome

**STR-5VN27-41-02** \$49.95

Midnight

**STR-5VN27-41-03** \$47.95

**e. Alternator Cover Insert**

Replaces stock alternator cover insert.

Chrome

**STR-5VN27-44-02** \$43.95

Midnight

**STR-5VN27-44-03** \$41.95

**f. Starter Cover**

Simple bolt-on design covers the existing starter end cap for a custom finish.

Fits '99-'07 Road Star models

Chrome

**STR-5VN27-46-02** \$69.95

Midnight

**STR-5VN27-46-03** \$69.95

**g. Fork Stem Cover**

Clean up the upper clamp with this easy-to-install cover.

Chrome

**STR-5VN27-06-01** \$36.95

Midnight

**STR-5VN27-06-02** \$34.95

**h. Front Master Cylinder Cover**

New die-cast cover simply bolts on over the stock front brake master cylinder. Bold new styling makes this a cure for the common part.

Chrome

**STR-5VN18-10-01** \$39.95

Midnight

**STR-5VN18-10-02** \$37.95

## 1. Billet Mirrors

Designed to fit a more aggressive personality, while maintaining excellent visibility. Available in two head shapes with three finishes to coordinate with accessory and original equipment components. Smooth and Brushed styles have holes in the stem. Left and right hand mirrors sold separately.

### Oval

Smooth, Left	
<b>STR-5PX13-41-00</b>	\$129.95
Smooth, Right	
<b>STR-5PX13-42-00</b>	\$129.95
Ball Milled, Left	
<b>STR-5PX13-31-00</b>	\$129.95
Ball Milled, Right	
<b>STR-5PX13-32-00</b>	\$129.95
Brushed, Left	
<b>STR-5PX13-61-00</b>	\$129.95
Brushed, Right	
<b>STR-5PX13-62-00</b>	\$129.95

### Tear Drop

Ball Milled, Left	
<b>STR-5PX13-11-00</b>	\$129.95
Ball Milled, Right	
<b>STR-5PX13-12-00</b>	\$129.95
Brushed, Left	
<b>STR-5PX13-51-00</b>	\$129.95
Brushed, Right	
<b>STR-5PX13-52-00</b>	\$129.95

## 2. Billet Mirrors

Each mirror and stem is highly polished and specially treated before chrome plating for an extra-durable finish. Left and right mirrors sold separately.

### Oval

Smooth, Left	
<b>STR-4NK13-41-00</b>	\$118.95
Smooth, Right	
<b>STR-4NK13-42-00</b>	\$118.95
Ball Milled, Left	
<b>STR-4NK13-31-00</b>	\$118.95
Ball Milled, Right	
<b>STR-4NK13-32-00</b>	\$118.95



## Tear Drop

Smooth, Left	
<b>STR-4NK13-21-00</b>	\$118.95
Smooth, Right	
<b>STR-4NK13-22-00</b>	\$118.95
Ball Milled, Left	
<b>STR-4NK13-11-00</b>	\$118.95
(Ball Milled Right not available)	

## 3. Billet Rider Floorboard Covers

These floorboard covers have a molded rubber cushion and ribs for a fresh look and added durability. Highly polished with a rich chrome finish to coordinate with other Star accessories. (Sold in pairs.)

<b>STR-4WM27-11-13</b>	\$279.95
Replacement Rubber, Left	
<b>STR-4WM27-11-21</b>	\$28.95
Replacement Rubber, Right	
<b>STR-4WM27-11-22</b>	\$28.95

## 4. Passenger Floorboards

Cast aluminum floorboards with rubber inserts designed to coordinate with the stock rider floorboards. Requires passenger floorboard mounts (STR-4WM57-40-01) for installation. (Sold in pairs.)

<b>STR-4YE57-20-02</b>	\$150.95
------------------------	----------

Replacement Rubber Inserts

(Order two if replacing rubber on both boards.)

<b>4YE-27433-00-00</b>	\$11.95
------------------------	---------

## 5. Billet Passenger Floorboards

These passenger floorboards incorporate a molded rubber cushion and ribs for style and durability. Highly polished with a rich chrome finish to coordinate with other Star accessories. Requires Passenger Floorboard Mounts (STR-4WM57-40-01) for installation.

<b>STR-4WM57-30-01</b>	\$230.95
------------------------	----------

Replacement Rubber

(Order two if replacing rubber on both boards.)

<b>STR-4WM57-30-21</b>	\$25.95
------------------------	---------

## Passenger Floorboard Mounts

(Not shown)

Use these mounts with either passenger floorboard option to replace the stock foot pegs for added passenger comfort. (Sold in pairs.)

<b>STR-4WM57-40-01</b>	\$75.95
------------------------	---------

## 6. Chrome Passenger Foot Pegs with Rubber Inserts

Chrome-plated foot pegs designed to replace stock passenger pegs. All hardware included for easy installation and perfect fit. (Sold in pairs.)

**STR-5BN36-20-03** \$65.95

## 7. Billet Brake Pedal Cover

Highly polished and specially treated to provide a durable and rich chrome finish. Includes rubber inserts that coordinate with other chrome accessories.

**STR-4WM27-12-03** \$49.95

Replacement Rubber (two required)

**STR-4NK27-12-08** \$9.95

## 8. Billet Single Arm Shift Lever

Replaces the stock heel/toe shifter for that tough "chopper" look and added foot room on the highway. Available in finishes that coordinate with other billet accessories.

Fits '99~'05 Road Star models

Smooth

**STR-4WM38-10-01** \$85.95

Ball Milled

**STR-4WM38-10-02** \$78.95

## 9. Billet Single Arm Shift Lever

Replace the stock heel/ toe shifter with this billet single arm shifter. Styled to coordinate with the billet brake pedal cover. Replaceable rubber inserts.

Fits '06~'10 Road Star models

**STR-1D738-10-00** \$118.95

Replacement Rubber Inserts

**STR-1D738-10-98** \$18.95

## 10. Billet Shift Arm with Heel Shifter

All the style of the single arm shifter, while retaining the stock heel shifter. The heel shifter has been moved back 1 inch to allow for more foot room on longer rides. (Dealer installation recommended.)

Fits '06~'10 Road Star models

**STR-1D738-20-00** \$150.95

Replacement Rubber Inserts

**STR-1D738-10-98** \$18.95

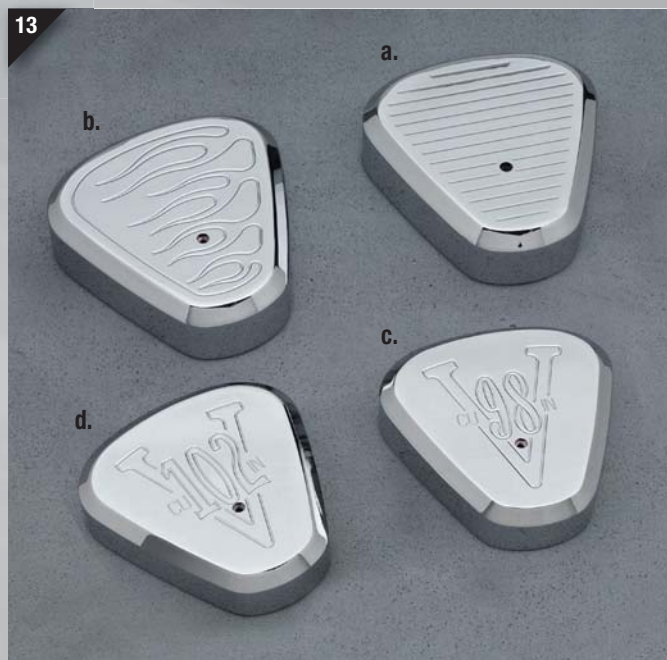

## 11. Billet Shift Linkage

Replace the stock shift linkage with this polished and chrome-plated billet piece.

Smooth

**STR-4WM27-67-01** \$50.95

Ball Milled

**STR-4WM27-67-02** \$52.95

## 12. Billet Shift Peg Covers

Precisely machined, then highly polished and specially treated for the most durable chrome finish. Metric Allen mounting screws included. (Sold in pairs.)

Fits '99~'05 Road Star models

Ball Milled

**STR-4NK27-13-02** \$49.95

## 13. Billet Air Cleaner Cover

Masterfully machined from an enormous piece of aluminum, and then polished and chrome-plated to a show-quality finish. This air cleaner cover simply replaces the stock piece while retaining the integrity of the factory air intake system.

a. Ball Milled

**STR-4WM27-72-02** \$214.95

b. Flamed

**STR-4WM27-72-04** \$214.95

c. "98 cu. in." logo  
Fits '99~'03 Road Star models

**STR-4WM27-72-03** \$214.95

d. "102 cu. in." logo  
Fits '04~'10 Road Star models

**STR-5VN27-72-03** \$214.95

### 1. Billet Drive Cover

Machined from billet-aluminum, then polished and chrome-plated to a show-quality finish. This cover replaces the stock cover to coordinate with other billet Star accessories. (Dealer installation recommended.)

Ball Milled

**STR-4WM27-83-02** \$193.95

Flamed

**STR-4WM27-83-03** \$193.95

### 2. Billet Drive Pulley Covers

Chrome-plated billet aluminum.

Smooth

**STR-4WM27-81-01** \$53.95

Ball Milled

**STR-4WM27-81-02** \$55.95

### 3. Billet Swingarm Pivot Covers

Precision-machined billet aluminum, highly polished, and chrome-plated. Chrome hardware included.

Ball Milled

**STR-4WM27-54-02** \$129.95

### 4. Billet Drive Pulleys

CNC-machined from 7075 aircraft-grade aluminum. These pulleys allow you to tailor your bike's gearing for quicker acceleration throughout the power range without having to change the drive belt. Works with the Billet Drive Pulley Case Set.

Available in 30, 31, and 32-tooth configurations (stock is 33 teeth).

Fits '99~'03 Road Star models

30-Tooth

**STR-4WM99-10-30** \$214.95

31-Tooth

**STR-4WM99-10-31** \$214.95

32-Tooth

**STR-4WM99-10-32** \$214.95

*NOTE: Use of a different drive pulley will affect the accuracy of the speedometer and odometer.*

*For closed-course competition use only (see Important Note below).*

### 5. Billet Drive Pulley Case Set

Precision-machined from billet aluminum. This case set replaces the existing front pulley cover, leaving the pulley visible. Kit includes chrome-plated billet pulley insert and chrome hardware that will give your bike a show-worthy appearance. Requires installation of Billet Swingarm Pivot Covers (sold separately).

Fits '99~'03 Road Star models

Smooth

**STR-4WM27-82-01** \$310.95

Ball Milled

**STR-4WM27-82-02** \$310.95

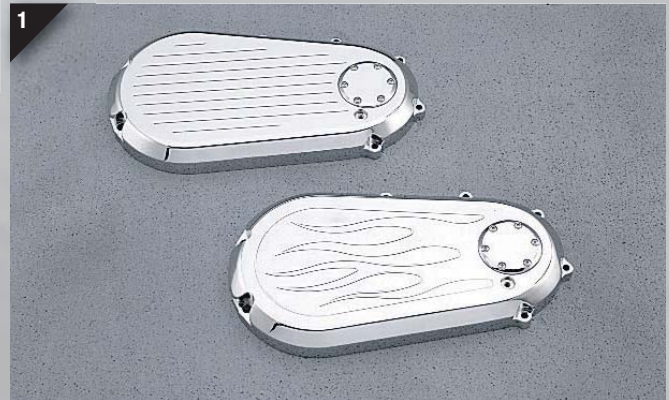

#### IMPORTANT NOTE:

All Star models are regulated by the EPA and state law. This accessory affects emissions and is for closed-course competition only. Use on public roads constitutes illegal tampering punishable by law.

## 6. Billet Idle Adjuster Cover

Press-on design installs in minutes over original-equipment idle adjuster knob.

Fits '99~'07 Road Star models  
**STR-4WM27-26-01** \$15.95

## 7. Billet Air Cleaner Bolt Covers

Custom-machined, polished, and chrome-plated pieces cover the air cleaner mounting bolts for a clean appearance. (Three-piece set.)

**STR-4WM27-71-00** \$36.95

## 8. Billet Push Rod Tube Covers

These covers add to the massive motor look. Machined from aircraft-quality aluminum, then polished and chrome-plated. Unique clip-on design allows for easy, yet secure, installation. (Sold in pairs.)

Fits '99~'03 Road Star models  
**STR-4WM27-45-02** \$80.95

## 9. Billet Rectifier Cover

Smooth

Fits '08~'10 Road Star models  
**STR-5VN27-68-02** \$74.95

Fits '05~'07 Road Star models  
**STR-5VN27-68-00** \$70.95

Fits '99~'04 Road Star models  
**STR-4WM27-68-00** \$70.95

## 10. Billet Front Axle Bolt Covers

Precisely machined, then highly polished and specially treated for the most durable chrome finish. Metric Allen mounting screws included.

(Sold in pairs.)

a. Round

Smooth

**STR-4WM27-04-01** \$96.95

Ball Milled

**STR-4WM27-04-02** \$96.95

b. Square

Smooth

**STR-4NK27-04-01** \$95.95

## 11a. Billet Fork Cap Covers

Smooth

**STR-4NK27-02-01** \$51.95

Ball Milled

**STR-4NK27-02-02** \$51.95

## 11b. Billet Fork Stem Nut Cover

Smooth

**STR-4YV27-06-01** \$26.95

Ball Milled

**STR-4YV27-06-02** \$26.95

## 12. Billet Ignition Switch Bezel

Replace the stock black piece with this chrome billet aluminum bezel.

**STR-4WM27-27-01** \$16.95

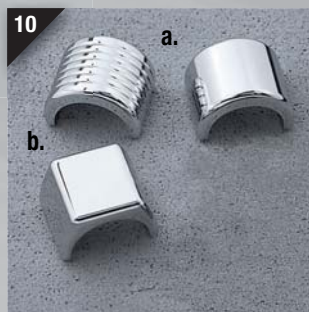
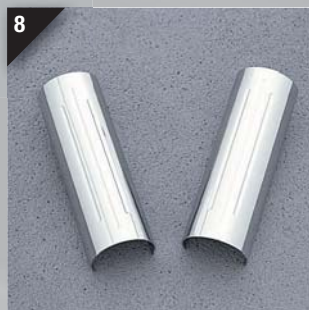

### 1. Billet Starter End Cap Cover

Simple bolt-on design covers the existing starter end cap for a clean finish. Coordinates with other Star billet accessories.

Fits '99~'07 Road Star models

Smooth

**STR-4WM27-46-01**     \$65.95

### 2. Billet Engine Covers

Both of these precision-machined, polished, and chrome-plated pieces simply replace stock covers to coordinate with other billet Star accessories.

**a.** Right Side Cam Cover

Ball Milled

**STR-4WM27-41-02**     \$52.95

**b.** Alternator Cover

Ball Milled

**STR-4WM27-44-02**     \$48.95



### 3. Billet Generator Access Cover

Polished and chrome-plated billet piece replaces the stock cover for a custom look.

Smooth

**STR-4WM27-47-01**     \$29.95

Ball Milled

**STR-4WM27-47-02**     \$29.95



### 4. Billet Rear Master Cylinder Cover

This precision-machined cover cleanly hides the rear master cylinder. Chrome hardware included for easy installation.

Fits '99~'07 Road Star models

Smooth

**STR-4WM27-35-01**     \$80.95

Ball Milled

**STR-4WM27-35-02**     \$80.95





5



### 5. Billet Rear Fender Hole Plugs

Use to plug the rear seat mounting bracket holes for a clean and detailed look. O-rings hold each plug in place. (Set of four.)

**STR-4NK27-32-01** \$32.95

6



### 6. Billet Rear Axle Adjusters

Replace stock adjusters for custom look. Finished to coordinate with other Star accessories. (Sold in pairs.)

Smooth

**STR-4WM27-57-01** \$104.95

Ball Milled

**STR-4WM27-57-02** \$104.95

7



### 7. Billet Choke Knob Cover

Installs in less than a minute with a unique screw-on design.

Fits '99~'07 Road Star models

**STR-4NK27-21-01** \$43.95



### 1. Billet Spark Plug End Covers

These machined billet pieces fit over the stock spark plug caps. (Sold in pairs.)

Ball Milled  
**STR-4WM27-65-02** \$52.95

### 2. Billet Banjo Joint Covers for Handlebar Reservoir

This two-piece design covers the banjo joints that attach to the handlebar reservoir.

**STR-4WM27-22-00** \$38.95

### 3. Billet Brake Caliper Accents

These highly polished, triple-plated billet aluminum covers are adhesive backed for quick, easy installation. (Three-piece set.)

Fits '99~'03 Road Star models  
Smooth  
**STR-4WM27-16-01** \$53.95  
Ball Milled  
**STR-4WM27-16-02** \$59.95

### 4. Billet Brake Caliper Bleeder Covers

Use to enhance the brake caliper bleeder joint for a detailed look. (Three-piece set.)

**STR-4WM27-29-01** \$35.95

### 5. Billet Banjo Joint Covers for Calipers

Covers the banjo joint head on each brake caliper. (Three-piece set.)

**STR-4WM27-23-01** \$29.95

### 6. Billet Oil Filter Cover

Simple design covers stock oil filter. Polished and chrome-plated for detailed appearance. Requires removal of oil filter for installation.

**STR-4WM27-49-02** \$69.95

### 7. Billet Wire Harness Guides

Replace the nylon cable-ties with these chrome guides. (Sold in pairs.)

**STR-4NK27-62-01** \$70.95

### 8. Billet Head Bolt Covers

Unique push-on design covers visible head bolt for a clean finish.

**STR-4WM27-37-01** \$22.95





**9. Chrome Timing Cover - Outer**  
Stock timing cover polished and chrome-plated to a show-worthy appearance.  
**STR-4WM59-20-00** \$75.95

**10. Chrome Decompression Lever Cover**  
Stock decompression lever cover is polished and chrome-plated to a show-worthy appearance.  
**STR-4WM59-70-00** \$28.95

**11. Chrome Master Cylinder Cover**  
Attach to the master cylinder reservoir for a personalized, highly polished, triple-chrome-plated look.  
**STR-4WM18-10-01** \$22.95

**12. Chrome Pulley Nut Covers**  
These chrome-plated polymer caps simply press on over the stock pulley nuts without having to remove the wheel. (Set of five.)  
**STR-4WM26-08-17** \$16.95



**13. Chrome Rear Brake Reservoir Cover**  
Polished and chrome-plated rear brake reservoir cover simply replaces stock cover for a customized look.  
**STR-4NK26-13-00** \$34.95

**14. Chrome Taillight Cover**  
Details the taillight for a custom look. Adhesive backed for quick and easy installation.  
Fits '99-'03 Road Star models  
**STR-4NK58-40-00** \$35.95

**15. Chrome Engine Bolt Kit**  
Kit includes over 60 chrome-plated smooth Allen bolts for your Road Star engine.  
**STR-4WM88-10-00** \$156.95

**16. Chrome Allen Bolt Plugs**  
Nickel-chrome-plated plugs are available in three sizes to fit most of the Allen bolts found on all Star models.  
5mm (Box of 20)  
**STR-4NK26-01-20** \$12.95  
6mm (Box of 10)  
**STR-4NK26-02-10** \$7.95  
8mm (Box of 10)  
**STR-4NK26-03-10** \$7.95



**17. Custom License Frames**  
License frames are available in two finishes. The smooth style features a 1/2" round molded edge with clear license cover and chrome backing plate. The ball milled style features chrome-plated billet-aluminum construction with the Star logo and chrome backing plate. Chrome mounting hardware is included with both styles.  
Smooth  
**STR-4NK26-25-00** \$59.95  
Ball Milled with Logo  
**STR-4NK27-01-03** \$96.95



**18. Billet License Plate Frame**  
Compact billet license frame kit includes all hardware and backing plate.  
Smooth  
**STR-5PX27-01-01** \$81.95  
Brushed  
**STR-5PX27-01-07** \$83.95



### 1. Billet Rear Fender Accents

Replaces stock "eyebrows" for a sleek custom look. (Sold in pairs.)  
**STR-4WM27-55-02** \$142.95



### 2. Chrome Metal Fender Tips

Cast metal fender tips are polished, and then chrome-plated to a brilliant finish for a classic look. (Installation requires drilling of fenders.)

Front of Front Fender  
**STR-4WM26-90-00** \$59.95

Rear of Front Fender  
**STR-4WM26-91-00** \$70.95

Rear Fender  
**STR-4WM26-92-00** \$86.95



### 3. Star Fender Ornament

This rich looking, solid steel, highly polished, triple-plated ornament proudly displays the Star logo.  
**STR-4NK14-01-00** \$99.95

### 4. Front Fender Trim Rail

Classic styling and brilliant triple-chrome finish enhances the Road Star front fender. (Not compatible with Chrome Front Fender Tip).  
**STR-4WM14-10-00** \$116.95



### 5. Solo Seat Rail

Styled to complement both stock and Star custom seats, this uniquely designed seat rail is polished and chrome-plated to a show-worthy appearance. Rail is for solo seat application only and not compatible with passenger seats.  
Fits '08~'10 Road Star models (compatible with all stock and accessory seats)  
**STR-5VN24-60-01** \$165.95  
Fits '99~'07 Road Star models  
**STR-4WM24-60-01** \$160.95

### 6. Saddlebag Guards

Helps protect saddlebags if your bike is dropped. Polished and chrome-plated for style as well as function. Compatible with both Star hard saddlebags and Silverado leather saddlebags. Saddlebag mounts (STR-5GA73-40-00) required for mounting on Road Star.  
**STR-5VN33-00-00** \$299.95

### 7. Saddlebag Trim Rails

These polished and chrome-plated trim rails wrap around either the hard or Silverado leather saddlebags adding to the flowing lines of the motorcycle. Saddlebag mounts and guards required for installation.  
Fits '04~'10 Road Star models  
**STR-5VN72-70-00** \$199.95



### 8. Tour Classic® Saddlebag Guards

Polished and chrome-plated for style as well as function. Help protect Tour Classic saddlebags if your bike is dropped. Guards fit Tour Classic Saddlebags and mounts only.

**STR-4WM33-00-00** \$166.95



### 9. Saddlebag Support Bars

Designed to help keep saddlebags off the fender sides and allow clearance for swingarm movement. Includes mounting hardware to use with or without backrest assembly.

**STR-4WM73-40-00** \$105.95

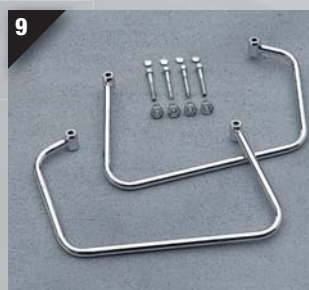

### 10. Engine Guards

Sturdy design, triple-chrome-plated finish and easy to install. 1" tubing. Fits all '99~'07, and (except in CA) '08~'10 Road Star models (Sold in pairs.)

**STR-4WM31-10-00** \$139.95

### 11. Big Bar Engine Guards

The ultimate in classic styling. The big 1-1/4" tubing matches the Road Star's big bike personality. (Not compatible with Lower Deflectors.)

**STR-5VN31-20-00** \$182.95

#### ⚠ WARNING

These engine guards may provide limited protection against cosmetic vehicle damage in certain situations, such as if the motorcycle tips over while stopped or moving slowly.

These engine guards are not manufactured or intended to protect the rider from injury in a collision.

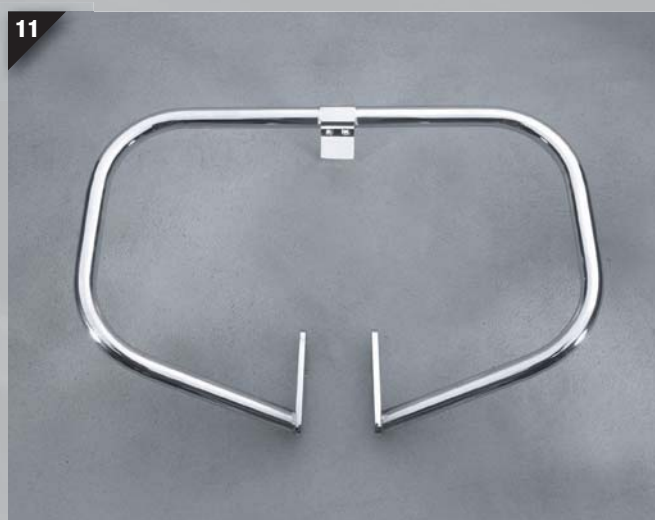

### 12. Luggage Rack

A simple design with upswept tail provides function with a brilliant chrome finish for exceptional style. Fits all '99~'03 Road Star models

**STR-4WM51-10-01** \$134.95



### 13. Rear Fender Rack

Unique styling complements the rear fender, while protecting the paint and providing a tie-down point for luggage.

**STR-4WM51-20-00** \$107.95



### 14. Rear Luggage Rack

Designed specifically for the Road Star, this rack attaches to the Silverado® backrest or Passenger Backrest Components (sold separately, page 8-37).

Fits '99~'07 Road Star models, and '08 Road Stars with fixed mount backrest.

**STR-5VP51-30-00** \$113.95

Fits Road Star models with Quick-Release Backrest System (STR-5VN51-41-00)

**STR-5VN51-31-00** \$113.95



These accessories fit all Road Star models unless otherwise noted.

**Billet Handlebar Risers and Flat Bars**

Designed for the custom drag-bike look, these billet risers and flat bar replace the stock bars and risers. Risers coordinate with other accessory and stock finishes (when used as a set, bars have 6-1/2" rise, 10-1/4" pullback, and 23-3/4" width).

**1. Handlebar Risers**

Smooth  
**STR-5PX75-50-08**      \$214.95

**2. Flat Bars**

May require the use of accessory grips.  
**STR-5PX75-14-00**      \$69.95

**3. Billet Handlebar Risers**

CNC-machined risers and upper clamp provide 2-1/4" rise and 1-1/4" pullback over stock risers. (Sold in pairs.)  
Smooth  
**STR-5PX75-70-01**      \$193.95  
Brushed  
**STR-5PX75-70-07**      \$203.95

*NOTE:*  
Depending on the positioning of handlebars being used, custom extended-length cables and hoses may be required.

**4. Road Star Handlebars**

The Road Star handlebar features wider and lower positioning (3-5/8" rise, 12" pullback, 33-5/8" width). May require the use of accessory grips.  
**STR-4WM75-13-00**      \$75.95

**5. Fat Double "T" Bars**

The Fat Double "T" Bars feature drag-bike styling with stout 1-1/4" diameter tubing swaged down to 1-inch at the grip area (6-1/2" rise, 10-1/2" pullback, 34-1/4" width). May require the use of accessory grips.  
**STR-4WM75-12-00**      \$160.95

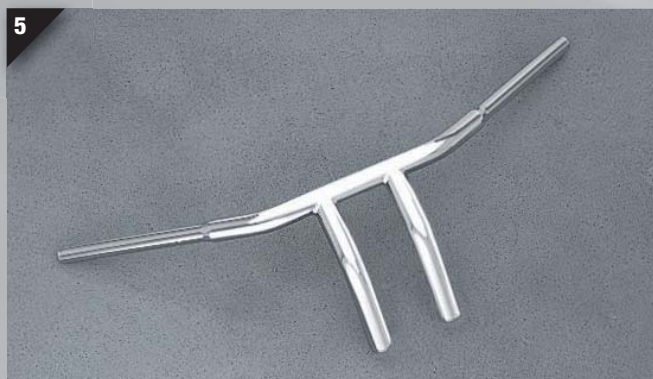
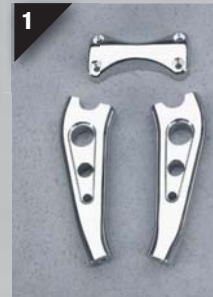

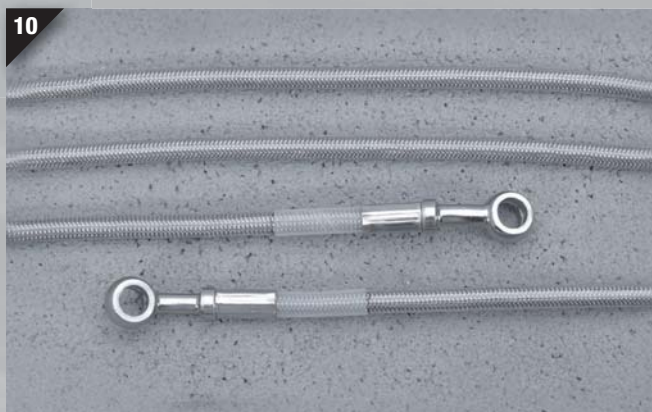

### 6. Chrome Instrument Visor

Cast metal visor is polished, and then chrome-plated to a brilliant finish for a classy look. Adhesive tape included for easy installation.

**STR-4WM04-00-00** \$55.95

### 7. Billet Handlebar Clamp

Precisely machined, highly polished and specially treated for a durable chrome finish.

Fits '99~'03 Road Star models

Ball Milled with Logo

**STR-4YV27-17-03** \$67.95

### 8. Chrome Grips

These custom grips include rubber ribs for styling and grip. Attractively priced and easy to install. (Sold in pairs.)

**STR-4NK37-10-11** \$59.95

### 9. Braided Stainless Steel Cables

Upgrade the appearance of your Star cruiser by replacing the stock black cables with these stainless steel braided cables built to exacting stock specifications. Nylon inner liner for smooth operation. Cable has a rugged clear coat on its full length to make it easier to clean, while helping to protect windshields and painted surfaces. (Dealer installation recommended.)

Throttle Cable Set

**STR-4WM48-10-SD** \$86.95

Clutch Cable

**STR-4WM48-20-SD** \$49.95

### 10. Braided Stainless Steel Brake Lines

All of our hydraulic lines are constructed using 308 stainless steel braided brake hose with a Teflon® inner liner. Brake line has a rugged clear coat on its full length to make it easier to clean, while helping to protect windshields and painted surfaces. (Dealer installation recommended.)

Fits '04~'10 Road Star models

Front Lower

**STR-5VN48-40-SD** \$96.95

Front Upper

**STR-5VN48-30-SD** \$59.95

Fits '99~'03 Road Star models

Front Lower

**STR-4WM48-40-SD** \$96.95

Front Upper

**STR-4WM48-30-SD** \$59.95

Fits '99~'10 Road Star

Rear

**STR-4WM48-50-SD** \$75.95

These accessories fit all Road Star models unless otherwise noted.

## Star Custom Accessory Windshields

Our tough polycarbonate windshields not only offer the superior fit and finish you would expect, we went a step further by treating them with the new-generation Quantum™ Coating to provide a long lasting, durable, protective finish.

### 1. Quick-Release Wide Windshields

These “fat” screens are 3 inches wider than the standard Silverado windshield. The unique, patented quick-release feature lets you match a change in weather or attitude before you ride. A lock is included for added security. Windshield mounts (STR-5VN03-40-00) required on Road Star models. Windshield mounts sold separately.

**NOTE: If switching from standard width to wide width replacement windshield, cable guide (STR-5VN03-22-00) required for installation.**

Windshield Assembly	
Tall (23" **)	
<b>STR-5VN03-30-00</b>	\$399.95
Medium (20-1/2" **)	
<b>STR-5VN07-30-00</b>	\$394.95
Short (17-1/2" **)	
<b>STR-5VN06-30-00</b>	\$389.95

Replacement Windshield Assembly	
Tall (23" **)	
<b>STR-5VN03-31-00</b>	\$168.95
Medium (20-1/2" **)	
<b>STR-5VN07-31-00</b>	\$154.95
Short (17-1/2" **)	
<b>STR-5VN06-31-00</b>	\$150.95

### 2. Quick-Release Windshields

The unique, patented quick-release feature lets you match a change in weather or attitude before you ride. A lock is included for added security. Windshield mounts (STR-5VN03-40-00) required on Road Star models. Windshield mounts sold separately.

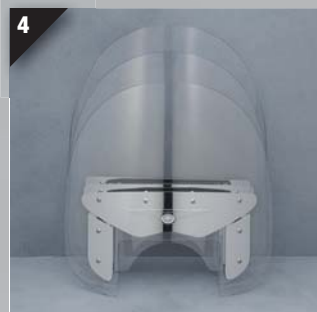
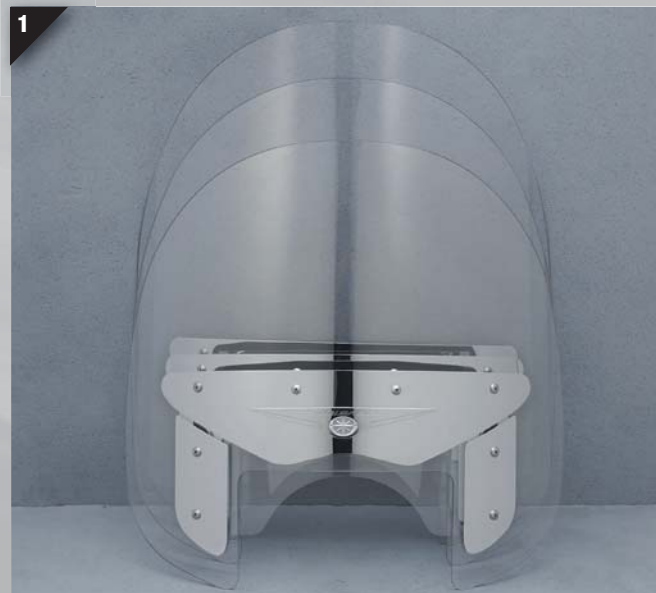

Windshield Assembly	
Tall (23" **)	
<b>STR-5VN03-10-00</b>	\$385.95
Medium (20-1/2" **)	
<b>STR-5VN07-10-00</b>	\$381.95
Short (17-1/2")	
<b>STR-5VN06-10-00</b>	\$377.95

Replacement Windshield	
Tall (23" **)	
<b>STR-5VN03-11-00</b>	\$168.95
Medium (20-1/2" **)	
<b>STR-5VN07-11-00</b>	\$150.95
Short (17-1/2")	
<b>STR-5VN06-11-00</b>	\$150.95



Quick-Release Windshield Mounts (Not Shown)	
Required for installation of Quick-Release Silverado Windshields.	
<b>STR-5VN03-40-00</b>	\$185.95

### 3. Quick-Release Windshield Mount Retro-Fit Kit

This unique retro-fit kit provides an easy-on/ easy-off solution for your existing rigid mount, Silverado and Road Star windshields. Kit includes lockable windshield mounts and vertical stays for easy conversion.

<b>STR-5VN03-70-00</b>	\$288.95
------------------------	----------

## 4. Wide Silverado Windshields

These “fat” screens are 3 inches wider than the standard Silverado windshield. All windshield assemblies will bolt directly onto the Silverado model or, with Windshield Mounts, onto the standard Road Star. Replace the windshield with one of a different height to match changes in weather or attitude.

Windshield Assembly	
Tall (23" **)	
<b>STR-5VN03-20-00</b>	\$386.95
Medium (20-1/2" **)	
<b>STR-5VN07-20-00</b>	\$386.95
Short (17-1/2" **)	
<b>STR-5VN06-20-00</b>	\$386.95

Replacement Windshield	
Tall (23" **)	
<b>STR-5VN03-21-00</b>	\$150.95
Medium (20-1/2" **)	
<b>STR-5VN07-21-00</b>	\$150.95
Short (17-1/2" **)	
<b>STR-5VN06-21-00</b>	\$150.95

## 5. Silverado Windshields

The standard-width windshield assemblies will bolt directly onto the Silverado model or, with Windshield Mounts, onto the standard Road Star. Replace the windshield with one of a different height to match changes in weather or attitude.

Windshield Assembly	
Tall (23" **)	
<b>STR-5GA03-10-00</b>	\$379.95
Medium (20-1/2" **)	
<b>STR-5GA07-10-00</b>	\$353.95
Short (17-1/2" **)	
<b>STR-5GA06-10-00</b>	\$353.95

Replacement Windshield	
Tall (23" **)	
<b>STR-4NL03-11-00</b>	\$182.95
Medium (20-1/2" **)	
<b>STR-4NL07-11-00</b>	\$182.95
Short (17-1/2" **)	
<b>STR-4NL06-11-00</b>	\$182.95

Windshield Mounts (Not Shown)	
Fits both wide and standard windshields.	
<b>STR-4WM03-40-00</b>	\$119.95



## 6. Clear Lower Wind Deflectors

These wind deflectors will complement all Road Star and Silverado windshields. Requires installation of Road Star Windshield Mounts. (Sold in pairs.) Not compatible with Big Bar Engine Guards.

- STR-4NL08-10-00** \$49.95  
Lower Deflector Mounting Hardware  
**STR-4NL08-40-00** \$116.95



## 7. Billet Lower Wind Deflectors

Mount to the Road Star Lower Wind Deflector mounting hardware. (Sold in pairs.) Not compatible with Big Bar Engine Guards.

- Smooth  
**STR-4NL08-20-01** \$129.95  
Ball Milled  
**STR-4NL08-20-02** \$137.95  
Lower Deflector Mounting Hardware  
**STR-4NL08-40-00** \$116.95



## 8. Road Star Windshield

Solar-bronze-tinted windshield features traditional styling. The 17-1/2" height\*\* provides upper body wind protection. Mounts allow 2" height adjustment. Requires Windshield Mounting Hardware (sold separately).

- STR-4WM06-10-00** \$299.95  
Windshield Mounting Hardware  
**STR-4WM03-40-00** \$119.95



## 9. Boulevard™ Windshield

Solar-bronze-tinted shield provides unique styling and deflects wind from your chest area (11" tall)\*\*. Includes triple-plated mounting hardware.

- STR-4NK05-00-30** \$149.95



## 10. Custom Tri-Bar Headlight

Give your bike a truly custom look by simply replacing your stock headlight with this halogen tri-bar style.

- STR-4WM45-10-00** \$106.95

## 11. Custom Tri-Bar Passing Lamps

Designed to coordinate with the Tri-Bar Headlight to complete the custom lighting package. Passing Lamp Mounts required for installation, sold separately.

- STR-4WM35-10-EA** \$129.95  
Replacement Glass Housing  
**STR-4WM35-50-EA** \$32.95

## 12. Passing Lamps

The classic look. Traditional-styled lamps include on/ off switch and wire harness. Choose sealed-beam or halogen (H3) lamps. Order lamps and mounting hardware separately. (Dealer installation recommended)

- Passing Lamps  
Sealed Beam  
**STR-4NK35-10-00** \$118.95  
Halogen  
**STR-4NK35-10-01** \$118.95  
Passing Lamp Mounts  
**STR-4WM35-40-00** \$119.95



Replacement Passing Light Bulb

- Sealed Beam  
**STR-4NK35-50-00** \$18.95  
Halogen (H3)  
**STR-4NK35-50-01** \$18.95  
Replacement Lens (H3)  
**STR-4NK35-17-01** \$22.95



## 13. Die-cast Passing Lamp Mounts

- Fits '08-'10 Road Star models  
**STR-5VN35-40-00** \$229.95

## 14. Visors

Triple-chrome-plated visors include a subtle Star logo.

- Headlight Visor  
**STR-4NK58-10-00** \$19.95  
Passing Light Visors  
**STR-4NK58-20-00** \$18.95  
Turn Signal Visors  
**STR-4NK58-30-00** \$17.95

These accessories fit all Road Star models unless otherwise noted.  
\*\*Height measured from top of headlight cutout to top of windshield.

## Custom Fiberglass Fenders

These are the same fenders as used on many Road Star customs featured in our Custom Series calendars. The front fender measures 1.5" longer than stock and the rear fender measures 3" longer than stock. All components are hand-laid gel coat fiberglass with hole locations pre-marked (some drilling is required for installation).



### 1. Extended Fenders

Front  
**STR-4WM19-11-XX** \$203.95  
Rear  
Fits '99~'03 Road Star models  
**STR-4WM19-21-XX** \$246.95

### 2. Expandable Custom Cover

This unique and versatile cover incorporates expandable windshield and backrest pockets to accommodate everything from a stock Road Star to a fully accessorized Silverado, yet maintains that custom-fit look. The top half uses premium Evolution® IV fabric that is breathable, water-repellent and UV-resistant. The bottom half is constructed of duck canvas for heat protection against exhaust pipes. Both materials provide excellent outdoor protection. (Not recommended for trailering.)

**STR-4WMCU-SC-VR** \$134.95

### 3. Dust Cover

Great for protecting your Star in wind-protected places such as a garage. The machine-washable knit polyester fabric will not scratch paint, windshield or chrome.

**STR-4WMDS-TC-VR** \$75.95





**Royal Star Tour Deluxe®  
 Accessories**
**Comfort Cruise™ Seats**

Comfort Cruise seats offer exceptional riding comfort. Whether you're going across town or across the country, Star Custom Accessories has a seat that is just right for your riding style.

Features include:

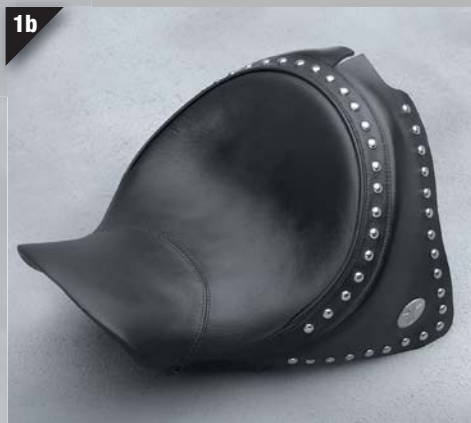
- Traditional styling and quality that you have come to expect from all Star Custom accessories
- Luxurious real leather seating panels
- Hand-laid fiberglass seat pan for consistent fit
- Soft foam edges for added comfort and protection for painted surfaces
- Soft foam nose for a close fit to the tank
- A "soft-to-touch" feel along with firmness and support for an all-day ride

**1. Solo**

- a. Plain with Skirt and Conchos  
**STR-1D624-10-H0** \$374.95  
 b. Studded with Skirt and Conchos  
**STR-1D624-10-H4** \$374.95

**Comfort Cruise™  
 Pillion Pads**

Comfort Cruise Pillion Pads offer a new dimension of passenger comfort. Designed to coordinate with Comfort Cruise Solo Seats to give your bike the right look, with a comfortable feel your passenger will appreciate.

**2. Tour**

- a. Plain  
**STR-1D625-30-H0** \$321.95  
 b. Studded  
**STR-1D625-30-H2** \$321.95

**3. Custom Backrest  
 Pad**

- Plain  
**STR-1D641-50-00** \$203.95  
 Studded (Shown)  
**STR-1D641-50-02** \$203.95

These accessories fit all '05~'10 Royal Star Tour Deluxe models unless otherwise noted.

**1. Leather Gas Cap Cover**

Unique design allows for easy cover-up of chrome gas cap. Coordinates with leather tank covers.

**STR-4XY49-90-00** \$22.95



**2. Mini Tank Cover**

This soft leather mini cover simply attaches to the fuel tank. Looks good and helps protect the paint from pant leg wear.

**STR-1D649-50-00** \$60.95



**3. Narrow Leather Tank Panel**

Tank Panels are constructed of hand-selected leather, double-stitched at stress points, and backed with suede leather to help protect the paint.

Plain

**STR-1D649-20-00** \$80.95

Studded

**STR-1D649-20-01** \$96.95

**4. Wide Leather Tank Panel with Pocket**

Tank Panels are constructed of hand-selected leather, double-stitched at stress points, and backed with suede leather to help protect the paint.

Plain

**STR-1D649-30-00** \$115.95

**5. Leather Tank Bra with Pockets**

Tank Bras are constructed of hand-selected leather, double-stitched at stress points, and backed with suede leather to help protect the paint. Includes two pockets for added convenience.

Plain

**STR-1D649-10-00** \$187.95

Studded

**STR-1D649-10-01** \$207.95



## 6. Classic Tour Trunks

High-quality, handcrafted leather is used to create this classic looking, ruggedly designed trunk. Internal frame holds the trunk's shape even when empty. The main compartment is a generous 12" x 13" x 7" size with three handy external storage compartments. Requires rear luggage rack.

Studded

**STR-4NK49-23-00** \$460.95

## 7. Saddlebag Liners

Liners provide carry-away convenience for your luggage. Constructed of heavy-duty ballistics nylon for durability, with an embroidered Star logo for a quality look and feel. (Sold in pairs.)

**STR-4XY73-90-00** \$80.95

## 8. Leather Tail Bag

This high-quality, all-leather bag is designed to attach quickly to our accessory rear fender rack to add over 300 cubic inches of storage. Includes a small zippered pouch on top. Built-in strap allows for easy carry-away. Foam integrated into the side panels helps the bag keep its shape even when empty. Coordinates with other Star leather products. (11" x 8" x 3")

Studded

**STR-4WM63-10-01** \$214.95

(Plain style shown not available)

## 9. Star Conchos

Use these Star Conchos to personalize your apparel, bags, tank panels, and more. (Sold in pairs.)

**STR-4NK78-10-00** \$22.95

## 10. Expandable Tank Bag

Made of tough, water-resistant ballistics nylon. Provides 550 cubic inches of convenient storage, and then quickly expands to over 900 cubic inches when you need extra room. Embroidered Star logo, five interior pockets, and reversible waterproof map pocket. For carry-away convenience, bag attaches to tank with special, high-strength magnets that are shielded to help protect electronic devices you may be carrying.

**STR-4WM64-21-00** \$96.95



## 11. Leather Tool Bags

Handcrafted leather bags with Star Concho provide both function and style. Dual mounting straps, with double stitching at stress points. (10" x 5" x 3")

Plain

**STR-4NK46-11-00** \$53.95

Fringed

**STR-4NK46-12-00** \$65.95

Studded

**STR-4NK46-13-00** \$65.95

## 12a. Mink Oil

Use to waterproof, preserve, and protect your leather accessories.

4-oz. Jar

**ACC-MINKC-RE-AM** \$2.95

## 12b. Saddle Soap

Use to clean, condition, and restore your leather accessories.

4-oz. Jar

**ACC-SADDL-ES-AP** \$2.95

## 12c. Black Leather Polish

Use to restore black leather to its natural luster by putting color back into the leather.

1.5-oz. Jar

**ACC-CREAM-PL-SH** \$2.49



**1. Billet Mirrors**

Designed to fit a more aggressive personality, while maintaining excellent visibility. Available in two head shapes and three finishes to coordinate with accessory and original equipment components. Smooth and Brushed styles have holes in stem. Left and right hand mirrors sold separately.

**Oval**

- Smooth, Left  
**STR-5PX13-41-00**      \$129.95
- Smooth, Right  
**STR-5PX13-42-00**      \$129.95
- Ball Milled, Left  
**STR-5PX13-31-00**      \$129.95
- Ball Milled, Right  
**STR-5PX13-32-00**      \$129.95
- Brushed, Left  
**STR-5PX13-61-00**      \$129.95
- Brushed, Right  
**STR-5PX13-62-00**      \$129.95

**Tear Drop**

- Ball Milled, Left  
**STR-5PX13-11-00**      \$129.95
- Ball Milled, Right  
**STR-5PX13-12-00**      \$129.95
- Brushed, Left  
**STR-5PX13-51-00**      \$129.95
- Brushed, Right  
**STR-5PX13-52-00**      \$129.95



**2. Billet Mirrors**

Each mirror and stem is highly polished, and specially treated before chrome plating for an extra-durable finish. Left and right mirrors sold separately.

**Oval**

- Smooth, Left  
**STR-4NK13-41-00**      \$118.95
- Smooth, Right  
**STR-4NK13-42-00**      \$118.95
- Ball Milled, Left  
**STR-4NK13-31-00**      \$118.95
- Ball Milled, Right  
**STR-4NK13-32-00**      \$118.95

**Tear Drop**

- Smooth, Left  
**STR-4NK13-21-00**      \$118.95
- Smooth, Right  
**STR-4NK13-22-00**      \$118.95
- Ball Milled, Left  
**STR-4NK13-11-00**      \$118.95
- (Ball-milled right not available)



### 3. Chrome Rear Brake Reservoir Cover

Polished and chrome-plated rear brake reservoir cover simply replaces stock cover for a customized look.

**STR-4NK26-13-00** \$34.95

### 4. Chrome Master Cylinder Covers

Attach to the master cylinder reservoirs for a personalized, highly-polished, triple-chrome-plated look. (Sold in pairs.)

**STR-4NK18-10-01** \$32.95

### 5. Chrome Battery Side Covers

Formed steel, highly polished, and triple plated for a brilliant chrome finish. (Sold in pairs.)

**STR-4NK26-30-00** \$208.95

### 6. Chrome Battery Cover Accents

Chrome-plated accent plates provide a personalized look and are easy to install with the adhesive backing. (Sold in pairs.)

**STR-4NK26-20-00** \$52.95

### 7. Billet Front Axle Bolt Covers

Precisely machined, highly polished, and specially treated for the most durable, quality chrome finish. Metric Allen mounting screws included.

**a.** Round  
Smooth

**STR-4WM27-04-01** \$96.95

Ball Milled

**STR-4WM27-04-02** \$96.95

**b.** Square  
Smooth

**STR-4NK27-04-01** \$95.95

### 8. Chrome Allen Bolt Plugs

Nickel-chrome-plated plugs are available in three sizes to fit most of the Allen bolts found on Star models.

5mm (Box of 20)

**STR-4NK26-01-20** \$12.95

6mm (Box of 10)

**STR-4NK26-02-10** \$7.95

8mm (Box of 10)

**STR-4NK26-03-10** \$7.95

### 9. Billet Front Brake Caliper Accents

These highly polished, triple-plated billet covers are adhesive-backed for quick and easy installation. Available in smooth or ball-milled finishes. (Two-piece set.)

Smooth

**STR-4XY27-16-01** \$41.95

Ball Milled

**STR-4XY27-16-02** \$41.95

### 10. Billet Carburetor Covers

Kit includes left-hand and right-hand covers, with all necessary hardware for easy installation.

Smooth

**STR-4XY27-42-01** \$91.95

Ball Milled

**STR-4XY27-42-02** \$91.95

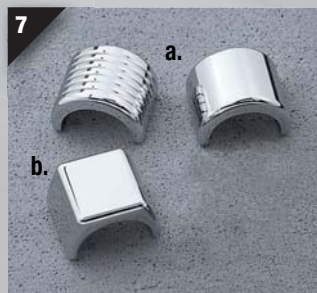

These accessories fit all '05-'10 Royal Star Tour Deluxe models unless otherwise noted.



**1. Billet Air Cleaner Covers**

Masterfully machined from two huge pieces of aluminum, then polished and chrome-plated for a show-quality finish. Both styles feature the Star logo. Covers replace stock pieces, while retaining the integrity of the factory air intake system. Requires installation of the reusable K&N® filters in the Replacement Filter Kit (STR-4XY09-48-00) sold separately.

- Smooth  
**STR-4XY27-72-01** \$423.95
- Ball Milled  
**STR-4XY27-72-02** \$434.95

Replacement Filter Kit (Not shown)  
High-quality, washable K&N® Filters.  
**STR-4XY09-48-00** \$111.95

**2. Shift Peg Covers**

Precisely machined, highly polished, and specially treated for the most durable quality chrome finish. Metric Allen mounting screws included. (Sold in pairs.)

- Ball Milled  
**STR-4NK27-13-02** \$49.95

**3. Billet Single Arm Shift Lever**

Replaces the stock dual-arm shift lever. Includes a special ball joint for easy installation.

- Ball Milled  
**STR-4NK38-00-02** \$118.95

**4. Billet Brake Pedal Cover**

Highly polished and specially treated to provide a durable, rich chrome finish. Both include rubber inserts that coordinate with other chrome accessories.

- STR-4NK27-12-03** \$48.95

Replacement Rubber (includes glue)  
**STR-4NK27-12-98** \$9.95

**5. Billet Brake Pedal Cover**

Unique clamshell design replaces the stock rubber brake pedal cover. Highly polished to provide a durable and rich chrome finish. Machined billet housing with replaceable rubber inserts.

- STR-1D727-12-03** \$86.95

Replacement Rubber Inserts  
**STR-1D727-12-98** \$19.95

**6. Billet Rider Floorboard Covers**

These floorboard covers incorporate a molded rubber cushion and ribs for a fresh look and added durability. Highly polished with a rich chrome finish to coordinate with other Star accessories.

- STR-4WM27-11-13** \$279.95

Replacement Rubber, Left  
**STR-4WM27-11-21** \$28.95  
Replacement Rubber, Right  
**STR-4WM27-11-22** \$28.95

**7. Billet Passenger Floorboards**

These passenger floorboards incorporate a molded rubber cushion and ribs for a fresh look and added durability. Highly polished with a rich chrome finish to coordinate with other Star Accessories.

- STR-4WM57-30-01** \$230.95

Replacement Rubber (Order two if replacing rubber on both boards.)  
**STR-4WM57-30-21** \$25.95

**8. Passenger Foot Peg Backing Plate Hole Plugs**

Four chrome-plated steel plugs provide a custom, clean solo look. (Backing Plate not included.)

- STR-4NK26-04-04** \$11.95



**9. Billet Fuel Tank Mount Covers**

These precision machined, polished and chrome plated billet mount covers replace the stock rubber fuel tank mount covers for a clean, custom appearance.

Smooth

**STR-1D627-09-01**      \$62.95

**10a. Billet Alternator Cover**

Simply replaces the stock cover.

Ball Milled

**STR-4NK27-44-02**      \$80.95

**10b. Billet Clutch Cover**

Adhesive backed for installation over the stock covers.

Ball Milled

**STR-4NK27-43-02**      \$77.95

**11. Billet Oil Filler Cap**

This brilliant triple-chrome-plated filler cap simply replaces the stock cap. Includes O-ring.

**STR-4NK27-14-01**      \$37.95

**12. Billet Ignition Switch Bezel**

Replace black stock piece with this chrome billet aluminum piece.

**STR-4XY27-27-01**      \$20.95





**1. Billet Banjo Joint Covers for Calipers**

This two-piece set covers the banjo joint head on each brake caliper.  
**STR-4YV27-23-01**     \$27.95

**2. Billet Banjo Joint Covers for Handlebar Reservoirs**

This two-piece design set covers the banjo joints that attach to the handlebar reservoirs.  
**STR-4NK27-22-00**     \$96.95

**3. Billet Wire Harness Guide**

Replace stock nylon wire harness guides with these billet guides. Large enough to hold wire harness and hydraulic lines. (Sold in pairs.)  
**STR-1D627-62-01**     \$70.95

**4. Billet Wire Harness Guides**

Replace the nylon cable-ties with these chrome guides. (Sold in pairs.)  
**STR-4NK27-62-01**     \$70.95

**5. Billet Choke Knob Cover**

Installs in less than a minute with a unique screw-on design.  
**STR-4NK27-21-01**     \$43.95

**6. Billet Motor Mount Bolt Covers**

Attach to the motor-mount bolt heads to hide the stock washer and provide a personalized chrome touch. (Sold in pairs.)  
 Smooth  
**STR-4NK27-18-01**     \$49.95  
 Ball Milled  
**STR-4NK27-18-02**     \$49.95

**7. Solo Seat Rail**

Styled to complement both stock and Star custom seats, this uniquely designed seat rail is polished and chrome-plated to a show-worthy appearance. Rail is for solo seat application only and not compatible with passenger seats.

**STR-1D624-60-01** \$172.95

**8. Saddlebag Lid Trim Rails**

Help protect your Tour Deluxe® saddlebag lids with these chrome-plated tubular trim rails. Designed to enhance the natural beauty of the saddlebag's shape. Requires drilling holes in the saddlebag lid.

**STR-1D672-50-00** \$177.95

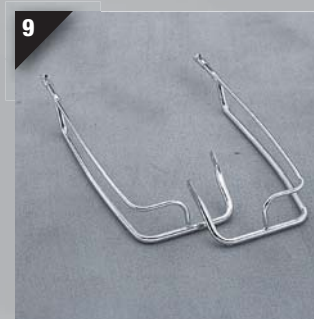
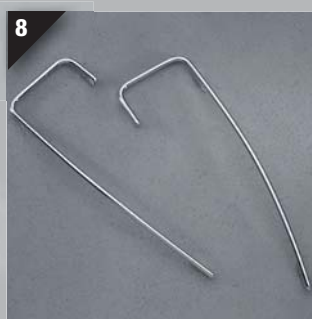
**9. Saddlebag Trim Rails**

These brilliantly polished and chrome-plated steel trim rails help protect saddlebags, while complementing the saddlebag design. All hardware is included for easy installation.

**STR-4XY72-70-00** \$214.95

**10. Billet Saddlebag Hinge Accents**

Simple to install, these adhesive-backed accents really dress up the saddlebag hinges. (Sold in pairs.)

Smooth

**STR-4XY27-56-01** \$76.95

**11. Chrome Saddlebag Filler Panel**

Designed to fill the gap between the saddlebag and rear fender with the backrest removed. Available in smooth and ball milled, both sporting the Star logo.

Smooth

**STR-1D672-80-01** \$214.95

Ball Milled

**STR-1D672-80-02** \$214.95

**12. Rear Luggage Rack**

Designed specifically for the Tour Deluxe, this new rack attaches to the passenger backrest retaining the quick release features.

**STR-1D651-30-00** \$155.95



**1. Rear Fender Rack**

Unique styling complements the rear fender, while protecting the paint and providing a tie-down point for luggage. For solo seat application only; not compatible with passenger seats.

**STR-1D651-20-00** \$118.95



**2. Front Fender Trim Rail**

Classic styling and a brilliant triple-chrome-plated finish enhance the look of the front fender. Not compatible with Chrome Front Fender Tip.

**STR-4XY14-10-00** \$139.95

**3. Chrome Metal Fender Tips**

Cast metal fender tips are polished and then chrome-plated to a brilliant finish for a classic look. (Installation requires drilling of fenders.)

Front/Front  
**STR-1D626-90-00** \$70.95

Rear/Front  
**STR-1D626-91-00** \$80.95

Rear  
**STR-1D626-92-00** \$86.95

**4. Chrome Taillight Cover**

Details the taillight for a custom look. Adhesive-backed for quick and easy installation.

**STR-4NK58-40-00** \$35.95



**5. Custom License Frames**

License frames are available in two styles. The smooth style features a 1/2" round molded edge with clear license cover and chrome backing plate. The ball-milled style features chrome-plated billet-aluminum construction with the Star logo and chrome backing plate. Chrome mounting hardware is included with both styles.

Smooth  
**STR-4NK26-25-00** \$59.95

Ball Milled with Logo  
**STR-4NK27-01-03** \$96.95

**6. Billet License Plate Frame**

Compact billet license frame kit includes all hardware and backing plate.

Smooth  
**STR-5PX27-01-01** \$81.95

Brushed  
**STR-5PX27-01-07** \$83.95



**7. Longhorn Handlebars**

These wide bars are all about attitude with a low, wide stance. (3-5/8" rise, 13-7/16" pullback, 35-7/8" width)

**STR-1D675-13-00** \$96.95

**Star Custom  
Accessory Windshields**

Our tough polycarbonate windshields not only offer the superior fit and finish you would expect, we went a step further by treating them with the new-generation Quantum™ Coating to provide a long lasting, durable, protective finish. This makes the windscreen three times more scratch-resistant than typical acrylic products, and also much more resistant to damage from bugs, stone chips, road grime, or even everyday cleaning. This extra attention to detail will help keep your windshield looking new longer, and that's a clear benefit you'll enjoy on every ride.

**8. Replacement  
Windcreens**

**a. Medium/ Clear**  
7" lower than stock.

**STR-1D607-11-00** \$182.95

**b. Short/ Smoke**

11" lower than stock. Dark smoke tint for all the attitude you could want.

**STR-1D606-11-35** \$182.95

**9. Tinted Lower Deflectors**

Dark tint to coordinate with short smoke windshield.

**STR-1D608-10-35** \$53.95

**10. Tinted Lower  
Wind Vents**

Unique styling complements the fairing lowers. Directs airflow into the footwell area when open.

**STR-1D608-80-00** \$199.95

**11. Billet Lower Deflectors**

These billet lower deflectors replace stock clear lowers.

Smooth

**STR-1D608-20-01** \$134.95

Ball Milled

**STR-1D608-20-02** \$150.95

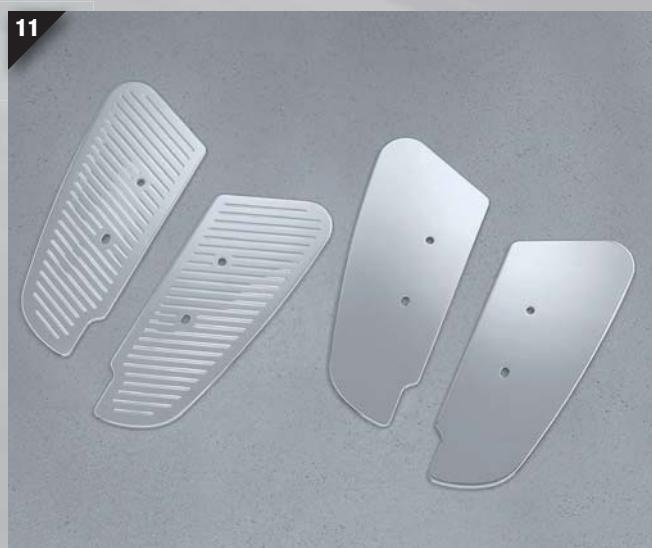
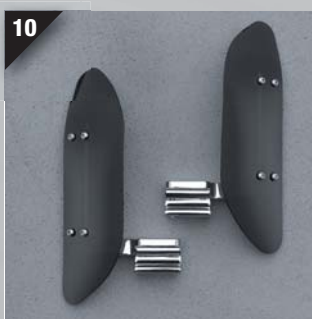
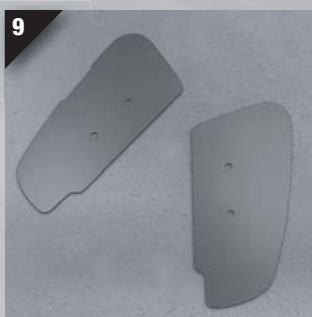
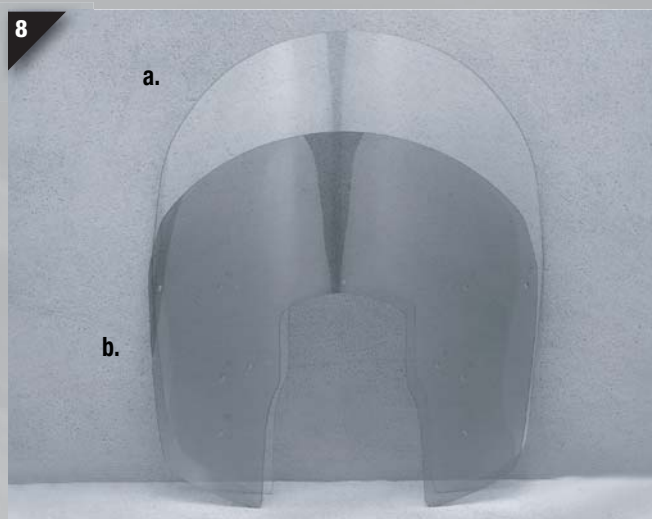



**1. Custom Tri-Bar Headlight**

Give your bike a truly custom look by simply replacing your stock headlight with this halogen tri-bar style.

**STR-4WM45-10-00** \$106.95

**2. Custom Tri-Bar Passing Lamps**

Designed to coordinate with the Tri-Bar headlight to complete the custom lighting package. Passing lamp mounts required for installation (STR-1D635-40-00) sold separately.

**STR-4WM35-10-EA** \$129.95

Replacement Glass Housing

**STR-4WM35-50-EA** \$32.95

**3. Passing Lamps**

The classic look. Traditional-styled lamps include on/ off switch and wire harness. Choose sealed-beam or halogen (H3) lamps. Order lamps and mounting hardware separately. (Dealer installation recommended.)

**Passing Lamps**

Sealed Beam

**STR-4NK35-10-00** \$118.95

Halogen

**STR-4NK35-10-01** \$118.95

**Passing Lamp Mounts**

**STR-1D635-40-00** \$150.95

Replacement Passing Light Bulb (Not shown)

Sealed Beam

**STR-4NK35-50-00** \$18.95

Halogen (H3)

**STR-4NK35-50-01** \$18.95

Replacement Lens (H3)

**STR-4NK35-17-01** \$22.95

**4. Visors**

Triple-chrome-plated visors include a subtle Star logo.

Headlight Visor

**STR-4NK58-10-00** \$19.95

Passing Light Visors

**STR-4NK58-20-00** \$18.95

Turn Signal Visors

**STR-4NK58-30-00** \$17.95



### 5. Braided Stainless Steel Throttle Cable Set

Upgrade the appearance of your Royal Star Tour Deluxe by replacing the stock black cables with these braided stainless steel cables built to exacting stock specifications. Nylon inner liner for smooth operation. Cable has a rugged clear coat throughout its full length to make it easier to clean while helping to protect windshields and painted surfaces. (Dealer installation recommended.)

**STR-1D648-10-SD**     \$86.95

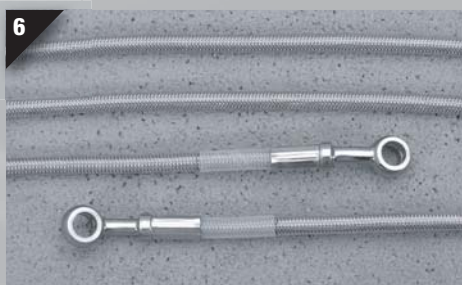

### 6. Braided Stainless Steel Brake and Clutch Lines

All of our hydraulic lines are constructed using braided 308 stainless steel brake hose with a Teflon® inner liner and feature full length, easy-to-clean rugged clear coat to protect windshields and painted surfaces. (Dealer installation recommended.)

Front Lower Brake Line  
**STR-1D648-40-SD**     \$96.95

Front Upper Brake Line  
**STR-1D648-30-SD**     \$59.95

Clutch Line  
**STR-1D648-20-SD**     \$75.95

### 7. Deluxe Expandable Full Cover

This custom fit cover is constructed from Evolution® IV woven fabric known for its superior outdoor protection. It is a durable fabric to help protect your Royal Star Tour Deluxe from scratches and small dents, with excellent breathable, water-repellent and UV-protection characteristics. The bottom half is constructed of duck canvas for heat protection against exhaust pipes. Other features include silk-screened Star logo and convenient tie-down loops. (Not recommended for trailering.)

**STR-1D6CU-SC-VR**     \$144.95



### 8. Windshield Storage Bag

Protect your windshield when you remove from bike. Durable fabric helps protect your Royal Star Tour Deluxe windshield from scratches. Features silk-screened Star logo.

**STR-1D6WS-ST-BG**     \$59.95







**Royal Star Venture®  
Accessories**

**1. Custom Passenger  
Backrest**

- a. Plain  
**STR-4XY62-10-H0**      \$285.95
- b. Studded  
**STR-4XY62-10-H2**      \$285.95

**2. Leather Gas Cap Cover**

Unique design allows for easy cover-up of chrome gas cap. Coordinates with leather tank covers.  
**STR-4XY49-90-00**      \$22.95

**3. Narrow Leather  
Tank Panel**

Tank Panels are constructed of hand-selected leather, double-stitched at stress points, and backed with suede leather to help protect the paint.

- Plain  
**STR-4XY49-20-00**      \$78.95
- Studded  
**STR-4XY49-20-01**      \$103.95

**4. Wide Leather Tank  
Panel with Pocket**

Tank Panels are constructed of hand-selected leather, double-stitched at stress points, and backed with suede leather to help protect the paint.

- Plain  
**STR-4XY49-30-00**      \$103.95
- Studded  
**STR-4XY49-30-01**      \$123.95

**5. Leather Tank Bra  
with Pockets**

Tank Bras are constructed of hand-selected leather, double-stitched at stress points, and backed with suede leather to help protect the paint.

- Plain  
**STR-4XY49-10-00**      \$187.95
- Studded  
**STR-4XY49-10-01**      \$207.95





### 6. Mini Tank Cover

This soft leather mini cover simply attaches to the fuel tank. Looks good and helps protect the paint from pant leg wear.

**STR-4XY49-50-00** \$53.95

### 7. Leather Grab Rail Bags

These unique, all-leather bags attach quickly to the passenger grab rails, offering easy access to small items such as cell phones and glasses, while leaving the grab rails open for use. (Sold in pairs.)

**STR-4XY73-71-00** \$107.95

### 8. Leather Trunk Rack Bag

Made of finely crafted leather, the Trunk Rack Bag is uniquely designed for easy removal. Integrated foam panels help bag hold its shape even when empty. Includes adjustable leather shoulder strap for easy carrying. Requires installation of the Trunk Rack (STR-4XY62-50-00), sold separately.

**STR-4XY62-61-00** \$481.95



### 9. Cordura® Trunk Rack Bag

This Trunk Rack Bag is made of tough, water-resistant ballistics nylon, coordinating perfectly with the Expandable Tank Bag. It also includes many extras like a built-in rain cover, three external pockets (two expandable), and embroidered Star logo. Sewn-in handle for easy handling when removed. Requires installation of the Trunk Rack (STR-4XY62-50-00), sold separately.

**STR-4XY62-60-00** \$96.95



### Luggage Liners

Liners provide carry-away convenience for your luggage. Constructed of heavy-duty ballistics nylon for durability, and an embroidered Star logo for a quality look and feel. Saddlebag liners are sold in pairs. The trunk liner includes a convenient shoulder strap.

### 10. Saddlebag Liners

**STR-4XY73-90-00** \$80.95

### 11. Trunk Liner

**STR-4XY62-70-00** \$62.95

### 12. Star Conchos

Use these Star Conchos to personalize your apparel, bags, tank panels, and more. (Sold in pairs.)

**STR-4NK78-10-00** \$22.95



### 13a. Mink Oil

Use to waterproof, preserve, and protect your leather accessories.

4-oz. Jar  
**ACC-MINKC-RE-AM** \$2.95

### 13b. Saddle Soap

Use to clean, condition, and restore your leather accessories.

4-oz. Jar  
**ACC-SADDL-ES-AP** \$2.95

### 13c. Black Leather Polish

Use to restore black leather to its natural luster by putting color back into the leather.

1.5-oz. Jar  
**ACC-CREAM-PL-SH** \$2.49

**1. Billet Mirrors**

Designed to fit a more aggressive personality, while maintaining excellent visibility. Available in two head shapes and three finishes to coordinate with accessory and original equipment components. Smooth and Brushed styles have holes in the stem. Left and right hand mirrors sold separately.

**Oval**

- Smooth, Left  
**STR-5PX13-41-00**      \$129.95
- Smooth, Right  
**STR-5PX13-42-00**      \$129.95
- Ball Milled, Left  
**STR-5PX13-31-00**      \$129.95
- Ball Milled, Right  
**STR-5PX13-32-00**      \$129.95
- Brushed, Left  
**STR-5PX13-61-00**      \$129.95
- Brushed, Right  
**STR-5PX13-62-00**      \$129.95

**Tear Drop**

- Ball Milled, Left  
**STR-5PX13-11-00**      \$129.95
- Ball Milled, Right  
**STR-5PX13-12-00**      \$129.95
- Brushed, Left  
**STR-5PX13-51-00**      \$129.95
- Brushed, Right  
**STR-5PX13-52-00**      \$129.95



**2. Billet Mirrors**

Each mirror and stem is highly polished and specially treated before chrome plating for an extra-durable finish. Left and right mirrors sold separately.

**Oval**

- Smooth, Left  
**STR-4NK13-41-00**      \$118.95
- Smooth, Right  
**STR-4NK13-42-00**      \$118.95
- Ball Milled, Left  
**STR-4NK13-31-00**      \$118.95
- Ball Milled, Right  
**STR-4NK13-32-00**      \$118.95

**Tear Drop**

- Smooth, Left  
**STR-4NK13-21-00**      \$118.95
  - Smooth, Right  
**STR-4NK13-22-00**      \$118.95
  - Ball Milled, Left  
**STR-4NK13-11-00**      \$118.95
- (Ball-milled right not available)

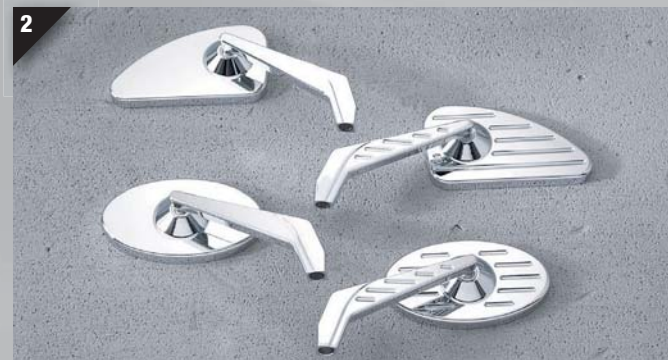



### 3. Shift Peg Covers

Precisely machined, highly polished, and specially treated for the most durable quality chrome finish. Metric Allen mounting screws included. (Sold in pairs.)

Ball Milled

**STR-4NK27-13-02** \$49.95

### 4. Billet Brake Pedal Cover

Highly polished and specially treated to provide a durable, rich chrome finish. Includes rubber inserts that coordinate with other chrome accessories.

**STR-4NK27-12-03** \$48.95

Replacement Rubber (includes glue)

**STR-4NK27-12-98** \$9.95



### 5. Billet Brake Pedal Cover

Unique clamshell design replaces the stock rubber brake pedal cover. Highly polished to provide a durable and rich chrome finish. Machined billet housing with replaceable rubber inserts.

**STR-1D727-12-03** \$86.95

Replacement Rubber Inserts

**STR-1D727-12-98** \$19.95



### 6. Billet Rider Floorboard Covers

These floorboard covers incorporate a molded rubber cushion and ribs for a fresh look and added durability. Highly polished with a rich chrome finish to coordinate with other Star accessories.

**STR-4WM27-11-13** \$279.95

Replacement Rubber, Left

**STR-4WM27-11-21** \$28.95

Replacement Rubber, Right

**STR-4WM27-11-22** \$28.95

### 7. Billet Passenger Floorboards

These passenger floorboards incorporate a molded rubber cushion and ribs for a fresh look and added durability. Highly polished with a rich chrome finish to coordinate with other Star Accessories. Simply replaces stock factory floorboards. (Sold in pairs.)

**STR-4WM57-30-01** \$230.95

Replacement Rubber

(Order two if replacing rubber on both boards.)

**STR-4NK57-20-98** \$32.95



### 1. Billet Air Cleaner Covers

Masterfully machined from two huge pieces of aluminum, then polished and chrome-plated for a show-quality finish. Both styles feature the Star logo. Covers replace stock pieces, while retaining the integrity of the factory air intake system. '02~'07 models require installation of the reusable K&N® filters in the Replacement Filter Kit (STR-4XY09-48-00) sold separately.

- Smooth  
**STR-4XY27-72-01**      \$423.95
- Ball Milled  
**STR-4XY27-72-02**      \$434.95

Replacement Filter Kit  
(Not shown)  
High quality, washable K&N® Filters.  
**STR-4XY09-48-00**      \$111.95

### 2. Billet Carburetor Covers

Kit includes left-hand and right-hand covers with all necessary hardware for easy installation.

- Smooth  
**STR-4XY27-42-01**      \$91.95
- Ball Milled  
**STR-4XY27-42-02**      \$91.95

### 3. Billet Front Axle Bolt Covers

Precisely machined, then highly polished and specially treated for the most durable chrome finish. Metric Allen mounting screws included. (Sold in pairs.)

- a.** Round  
Smooth  
**STR-4WM27-04-01**      \$96.95
- Ball Milled  
**STR-4WM27-04-02**      \$96.95
- b.** Square  
Smooth  
**STR-4NK27-04-01**      \$95.95

### 4. Billet Front Brake Caliper Accents

These highly polished, triple-plated billet covers are adhesive-backed for quick and easy installation. Available in smooth or ball-milled finish. (Two-piece set.)

- Smooth  
**STR-4XY27-16-01**      \$41.95
- Ball Milled  
**STR-4XY27-16-02**      \$41.95

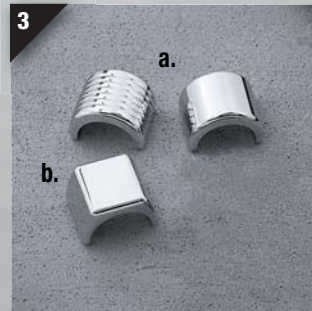

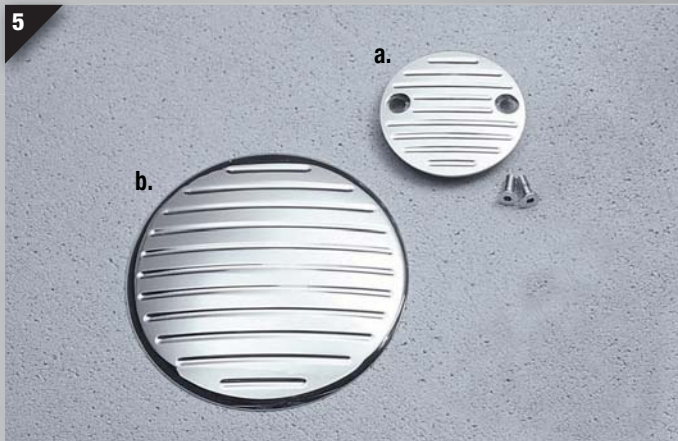

**5a. Billet Alternator Cover**

Simply replaces the stock cover.

Ball Milled

**STR-4NK27-44-02** \$80.95

**5b. Billet Clutch Cover**

Adhesive backed for installation over the stock covers.

Ball Milled

**STR-4NK27-43-02** \$77.95



**6. Billet Oil Filler Cap**

This brilliant triple-chrome-plated filler cap simply replaces the stock cap. Includes O-ring.

**STR-4NK27-14-01** \$37.95

**7. Billet Ignition Switch Bezel**

Replace black stock piece with this chrome billet aluminum piece.

**STR-4XY27-27-01** \$20.95



**8. Billet Banjo Joint Covers for Calipers**

This two-piece set covers the banjo joint head on each brake caliper.

**STR-4YV27-23-01** \$27.95

**9. Billet Banjo Joint Covers for Handlebar Reservoirs**

This two-piece design set covers the banjo joints that attach to the handlebar reservoirs.

**STR-4NK27-22-00** \$96.95



**10. Billet Handlebar Clamp**

Precisely machined, highly polished, and specially treated for a durable chrome finish.

Ball Milled

**STR-4YV27-17-03** \$67.95



**11. Billet Wire Harness Guides**

Replace the nylon cable-ties with these chrome guides. (Sold in pairs.)

**STR-4NK27-62-01** \$70.95

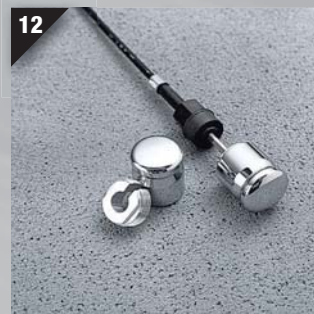

**12. Billet Choke Knob Cover**

Installs in less than a minute with a unique screw-on design.

**STR-4NK27-21-01** \$43.95



**13. Billet Fuel Tank Mount Covers**

These precision-machined, polished, and chrome-plated billet covers replace the stock rubber fuel tank mount covers for a clean, custom appearance.

Smooth

**STR-1D627-09-01** \$62.95

**1. Chrome Rear Brake Reservoir Cover**

Polished and chrome-plated rear brake reservoir cover simply replaces stock cover for a customized look.

**STR-4NK26-13-00**     \$34.95



**2. Chrome Master Cylinder Covers**

Attach to the master cylinder reservoirs for a personalized, highly polished, triple-chrome-plated look. (Sold in pairs.)

**STR-4NK18-10-01**     \$32.95



**3. Chrome Battery Side Covers**

Formed steel, highly polished and triple plated for a brilliant chrome finish. (Sold in pairs.)

**STR-4NK26-30-00**     \$208.95



**4. Chrome Allen Bolt Plugs**

Nickel-chrome-plated plugs are available in three sizes to fit most of the Allen bolts found on Star models.

5mm (Box of 20)

**STR-4NK26-01-20**     \$12.95

6mm (Box of 10)

**STR-4NK26-02-10**     \$7.95

8mm (Box of 10)

**STR-4NK26-03-10**     \$7.95



**5. Billet Saddlebag Hinge Accents**

Simple-to-install, these adhesive-backed accents really dress up the saddlebag hinges. (Sold in pairs.)

Smooth

**STR-4XY27-56-01**     \$76.95

**6. Chrome Battery Cover Accents**

Chrome-plated accent plates provide a personalized look and are easy to install with the adhesive backing. (Sold in pairs.)

**STR-4NK26-20-00**     \$52.95





### 7. Saddlebag Lid Trim Rails

Help protect your saddlebag lids with these chrome-plated tubular trim rails. Designed to enhance the natural beauty of the saddlebag's shape. Requires drilling holes in the saddlebag lid.

**STR-1D672-50-00** \$177.95

### 8. Saddlebag Trim Rails

These brilliantly polished and chrome-plated steel trim rails help protect saddlebags, while complementing the saddlebag design. All hardware is included for easy installation.

**STR-4XY72-70-00** \$214.95

### 9. Trunk Rack

Polished and chrome-plated tubular steel construction with upswept tail and hump guard to help secure load.

**STR-4XY62-50-00** \$179.95

### 10. Chrome Metal Fender Tips

Cast metal fender tips are polished, and then chrome-plated to a brilliant finish for a classic look. (Installation requires drilling of fenders.)

Front of Front Fender  
**STR-1D626-90-00** \$70.95  
Rear of Front Fender  
**STR-1D626-91-00** \$80.95  
Rear Fender  
**STR-1D626-92-00** \$86.95

### 11. Front Fender Trim Rail

Classic styling and a brilliant triple-chrome-plated finish enhance the look of the Royal Star Venture front fender. Not compatible with Chrome Front Metal Fender Tip.

**STR-4XY14-10-00** \$139.95

### 12. Chrome Fender Tips - Plastic

Classic fender accents add the look of thick, rich chrome plating. Injected-molded design has strong adhesive backing for quick, secure installation.

Rear of Front Fender  
**STR-4NK26-91-00** \$118.95  
Rear Fender  
**STR-4NK26-92-00** \$118.95

### 13. Chrome Taillight Cover

Details the taillight for a custom look. Adhesive backed for quick and easy installation.

**STR-4NK58-40-00** \$35.95

### 14. Custom License Frames

License frames are available in two styles. The smooth style features a 1/2" round molded edge with clear license cover and chrome backing plate. The ball-milled style features chrome-plated billet aluminum construction with the Star logo and chrome backing plate. Chrome mounting hardware is included with both styles.

Smooth  
**STR-4NK26-25-00** \$59.95  
Ball Milled with Logo  
**STR-4NK27-01-03** \$96.95

### 15. Billet License Plate Frame

Compact billet license frame kit includes all hardware and backing plate.

Smooth  
**STR-5PX27-01-01** \$81.95  
Brushed  
**STR-5PX27-01-07** \$83.95

These accessories fit all Royal Star Venture models unless otherwise noted.



**Star Custom  
Accessory Windshields**

Star Custom Accessories offer advantages and features that add to their value. Our windshields, for example, not only offer the superior fit and finish you would expect, we went a step further by using a hard-coated polycarbonate windscreen material. This makes the windscreen three times more scratch-resistant than typical acrylic products, and also much more resistant to damage from bugs, stone chips, road grime, or even everyday cleaning. This extra attention to detail will help keep your windshield looking new longer, and that's a clear benefit you'll enjoy on every ride.

**1. Wide Windshields**

Shield is 4 inches wider than the stock windshield for increased wind protection and comfort. These wide screens are available in Tall and Short heights.

- a. Tall (17-1/2")  
**STR-4XY02-60-00**      \$203.95
- b. Short (12-1/2")  
**STR-4XY02-50-00**      \$187.95

c. Low-Boy Sport Shield  
At a low 9-inch height, this screen is long on attitude and short on wind protection, giving you back that "wind in the face" feeling you thought you could never have on a dresser.

- STR-4XY02-20-00**      \$174.95

**2. Tinted Lower Wind Vents**

Unique styling complements the fairing lowers. Directs airflow into the footwell area when open.

- STR-1D608-80-00**      \$199.95

**3. Visors**

Triple-chrome-plated visors include a subtle Star logo.

- Headlight Visor  
**STR-4NK58-10-00**      \$19.95
- Passing Light Visors  
**STR-4NK58-20-00**      \$18.95
- Turn Signal Visors  
**STR-4NK58-30-00**      \$17.95

**4. Passing Lamps**

The classic look. Lamp kit includes traditional-styled lamps with a remote, dash-mounted switch and all necessary wiring. Mounting hardware sold separately. (Dealer installation recommended.)

- Passing Lamps  
**STR-4XY35-10-00**      \$118.95
- Passing Lamp Mounts  
**STR-4XY35-40-00**      \$150.95
- Replacement Passing Lamp Bulb  
**STR-4NK35-50-00**      \$18.95

**5. Travel Trunk Wing with Light**

Designed to complement the flowing lines of the Royal Star Venture, this spoiler kit combines style and function with the integrated LED running/ brake light. Kit includes all necessary wiring and hardware.

- Primer (All models)  
**STR-4XY62-03-00**      \$267.95
- Liquid Silver ('05 model)  
**STR-4XY62-03-LS**      \$267.95
- Radical White ('04 model)  
**STR-4XY62-03-RW**      \$267.95
- Raven ('04~'07 and '10 models)  
**STR-4XY62-03-RA**      \$267.95
- Onyx ('03 model)  
**STR-4XY62-03-YB**      \$267.95
- Raspberry Metallic ('03 model)  
**STR-4XY62-03-RM**      \$267.95
- Dark Silver ('08 model)  
**STR-4XY62-03-DS**      \$267.95
- Black Cherry ('06 and '08 models)  
**STR-4XY62-03-BC**      \$267.95
- Candy Red ('09 model) (Shown)  
**STR-4XY62-03-CR**      \$267.95
- Seashell ('09 model)  
**STR-4XY62-03-SS**      \$267.95

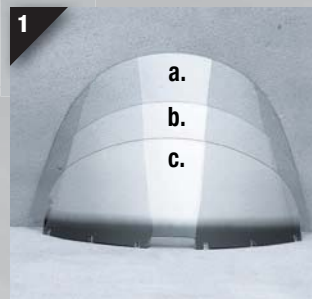

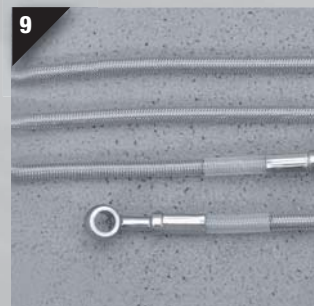
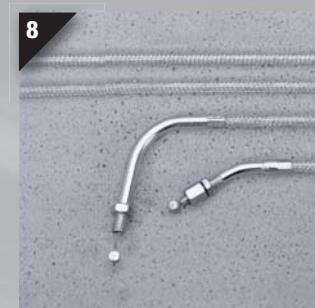
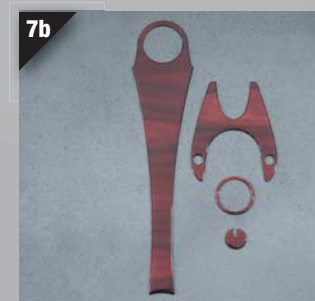
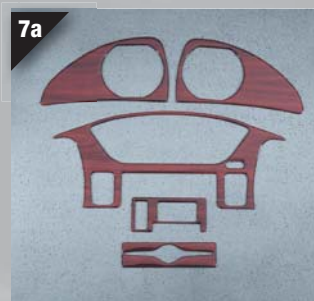
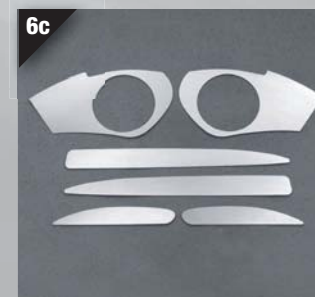
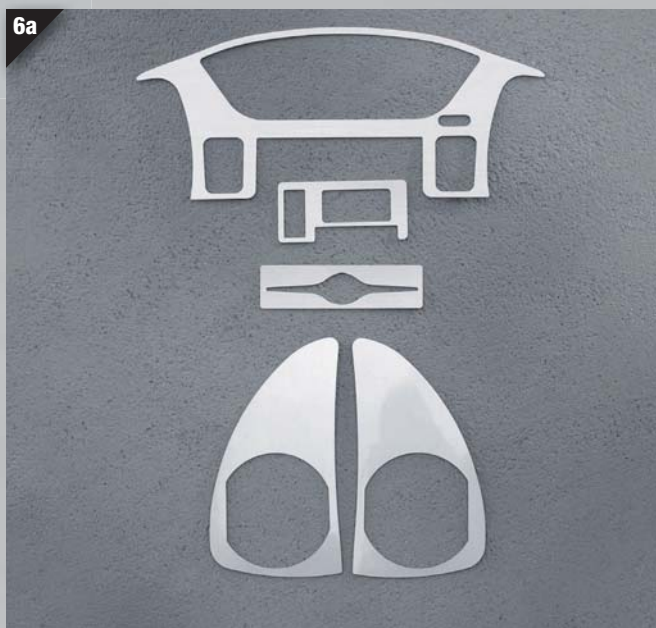

### Trim Accent Sets

Accent the dash, fuel tank, and travel trunk/ saddlebag areas of your Royal Star Venture with these custom-fit trim packages. (Sold separately.) Choose from either rich genuine rosewood veneer or brushed aluminum finish. Easy to apply.

### 6. Brushed Aluminum

- a. Dash  
**STR-4XY26-72-0A** \$203.95
- b. Fuel Tank  
**STR-4XY26-73-0A** \$139.95
- c. Travel Trunk  
**STR-4XY26-74-0A** \$182.95

### 7. Wood Grain

- a. Dash  
**STR-4XY26-72-0R** \$203.95
- b. Fuel Tank  
**STR-4XY26-73-0R** \$139.95
- c. Travel Trunk  
**STR-4XY26-74-0R** \$182.95

### 8. Braided Stainless Steel Throttle Cable Set

Upgrade the appearance of your Royal Star Venture by replacing the stock black cables with these braided stainless steel cables built to exacting stock specifications. Nylon inner liner for smooth operation. Cable has a rugged clear coat throughout its full length to make it easier to clean, while helping to protect windshields and painted surfaces. (Dealer installation recommended.)

- STR-4XY48-10-SD** \$86.95

### 9. Braided Stainless Steel Brake and Clutch Lines

All of our hydraulic lines are constructed using braided 308 stainless steel brake hose with a Teflon® inner liner and feature full-length, easy-to-clean rugged clear coat to protect windshields and painted surfaces. (Dealer installation recommended.)

- Front Lower Brake Line  
**STR-4WM48-40-SD** \$96.95
- Front Upper Brake Line  
**STR-4XY48-30-SD** \$59.95
- Clutch Line  
**STR-4XY48-20-SD** \$75.95



These accessories fit all Royal Star Venture models unless otherwise noted.

### 1. 6-Disc Remote CD Changer by Clarion®

This remote 6-disc CD changer is designed to fit into the saddlebag and work as an integral part of your Royal Star Venture Audio System. Enjoy up to seven hours or more of continuous music of your choice. To help reduce skipping when traveling down less-than-perfect highways this CD changer features a spring-loaded, silicone-oil-dampened suspension system and 8-times over-sampling. Its special laser assembly, with a highly accurate focusing servo tracking system, provides unmatched audio clarity. Kit includes CD changer, custom cable, mounting bracket and hardware. (Dealer installation recommended.)  
**STR-CDCHG-00-00** \$611.95



### 2. Helmet Headsets

Built to maximize the sound quality and CB clarity of the Royal Star Venture audio system. The J&M® headsets feature DynaPort® helmet speakers for great music fidelity. The AeroMike® III microphone helps provide outstanding voice clarity with excellent ambient and wind noise reduction. Each kit includes a patch cord. Available for either open or full-face helmets.

- a. Open Face  
**STR-4XY89-50-KT** \$214.95
- b. Full Face  
**STR-4XY89-60-KT** \$214.95

Replacement Patch Cord, Upper (Not shown)  
**STR-4XY89-20-K2** \$25.95



### 3. Deluxe Full Cover

This custom fit cover is constructed from Evolution® IV woven fabric known for its superior outdoor protection. It is a durable fabric to help protect your Royal Star Venture from scratches and small dents with excellent breathable, water-repellent and UV-protection characteristics. The bottom half is constructed of duck canvas for heat protection against exhaust pipes. Other features include silk-screened Star logo and convenient tie-down loops. (Not recommended for trailering.)  
**STR-4XYDX-CV-R1** \$139.95



### 4. Travel Cover

This lightweight travel cover is made of sturdy 225D polyester and has a water-repellent/ vapor-permeable finish. Packs up small in its own drawstring storage bag, so it's easy to take on a trip. (Not recommended for trailering.)  
**STR-4XYTR-CV-R1** \$96.95

**Royal Star® Accessories****1. Passenger Backrest and Seat Kit Components**

A three-piece system with triple-chrome plating. The low upright is angled forward to complement the standard model passenger seat and custom pillion pads. Standard backrest pads coordinate with stock seats.

- a. Backrest Sidearms**  
Fits '96~'01 Standard  
**STR-5GA41-10-00** \$182.95
- b. Backrest Upright**  
Low  
**STR-4NK41-30-01** \$150.95  
Tall  
**STR-5GA41-30-02** \$155.95

**2. Backrest Pads**

- Fits '97~'01 Tour Deluxe models,  
'98~'00 Tour Classic models  
**4YE-2840F-01-00** \$151.76  
Fits '96~'01 Standard  
**STR-4NK41-50-01** \$59.95



## STAR

### Royal Star® Accessories

#### 1. Leather Lever Skins

Cut from the finest top-grain leather. Attaches quickly and easily with high-quality laces. (Sold in pairs.)

**STR-4NK37-30-21** \$17.95



#### 2. Star Conchos

Use these Star Conchos to personalize your apparel, bags, tank panels, and more. (Sold in pairs.)

**STR-4NK78-10-00** \$22.95



#### 3. Backrest Emblem

Brilliantly chrome-plated with a gold Star Concho that proudly displays the Star logo.

**STR-4NK26-34-10** \$48.95



#### 4. Expandable Custom Cover

This custom fit cover is constructed from Evolution® IV woven fabric known for its superior outdoor protection. It is a durable fabric to help protect your Royal Star from scratches and small dents with excellent, breathable, water-repellent and UV-protection characteristics. The bottom half is constructed of duck canvas for heat protection against exhaust pipes. Other features include silk-screened Star logo and convenient tie-down loops. (Not recommended for trailering.)

**STR-4WMCU-SC-VR** \$134.95



#### 5. Dust Cover

Great for protecting your Star in wind protected places such as a garage. One size fits all Royal Stars, from a fully dressed Tour Classic to the standard model. The machine washable knit polyester fabric will not scratch paint, windshield, or chrome.

**STR-4WMDS-TC-VR** \$75.95



## 6. Tour Classic® Saddlebags

A distinctive design, handcrafted quality leather with an internal frame that holds the saddlebag's shape when empty. Includes a zippered pouch in the lid to keep small items separate (12" x 20" x 8").

Plain

**STR-4NL73-01-00** \$849.95

Studded

**STR-4NL73-02-00** \$878.95

Mounting Hardware

**STR-4NL73-40-00** \$149.95



## 7a. Saddlebag Rain Covers

These covers for original-equipment saddlebags are constructed of a special waterproof vinyl-coated material with sealed seams, a canvas bottom for hot exhaust protection, and a convenient pull-string closure.

Fit '96~'97 Tour Classic models

**STR-4NL73-80-00** \$32.95

## 7b. Saddlebag Liner

These liners for original-equipment saddlebags provide carry-away convenience for your gear. Constructed of heavy ballistics nylon for durability and a quality look and feel. (Sold individually.)

Fit '99~'01 Tour Deluxe models

**STR-4XY73-90-00** \$80.95



## Throw-Over Saddlebags

These handcrafted, throw-over design leather bags feature a plastic base insert and a hard rubber back to help hold their shape when empty. Interior pockets and zippered pouch included. Saddlebag Support Bars (sold separately) required for installation.

## 8. Star Slant Saddlebags

(10" x 15-1/2" x 5")

Plain

**STR-4NK73-10-00** \$369.95

Fringed

**STR-4NK73-10-01** \$407.95

Studded

**STR-4NK73-10-02** \$417.95

## 9. Classic Deluxe Saddlebags

(10" x 15-1/2" x 5")

Plain

**ABA-3JK73-00-02** \$343.95

Fringed

**ABA-3JK73-00-00** \$374.95

Studded

**ABA-3JK73-00-01** \$407.95

## 10. Classic Saddlebags

(10" x 12" x 4-1/2")

Plain

**ABA-3JK73-00-04** \$296.95

Fringed

**ABA-3JK73-00-05** \$343.95

Studded

**ABA-3JK73-00-03** \$343.95



## 11. Slant Saddlebags

(10" x 12" x 4-1/2")

Plain

**ABA-3JK73-00-06** \$321.95

Fringed

**ABA-3JK73-00-07** \$353.95

Studded

**ABA-3JK73-00-08** \$386.95



### 1. Cruiselite® Classic Saddlebags

These handcrafted, throw-over design bags are made of a premium synthetic material. Internal metal frame, plastic base insert, and a hard rubber back help hold the bag's shape when empty. Saddlebag Support Bars (sold separately) required for installation.

(10" x 12" x 4-1/2")

Plain	
<b>STR-5KS73-50-00</b>	\$259.95
Studded	
<b>STR-5KS73-50-02</b>	\$269.95

### 2. Classic Tour Trunk

High-quality, handcrafted leather is used to create this classic looking, ruggedly designed trunk. Internal frame holds the trunk's shape even when empty. Has a generous 12" x 13" x 7" main compartment with three handy external storage compartments. Requires rear luggage rack.

Studded	
<b>STR-4NK49-23-00</b>	\$460.95

### 3. Leather Windshield Bags

Constructed of premium supple leather and includes special mount brackets. Designed to fit all Tour Classic and Road Star windshields. Twist closure for easy access.



Plain	
<b>STR-4NK46-21-00</b>	\$65.95
Studded	
<b>STR-4NK46-23-00</b>	\$65.95

### 4. Leather Tool Bags

Handcrafted leather bags with Star Concho. Dual mounting straps and double stitching at stress points.

(10" x 5" x 3")	
Plain	
<b>STR-4NK46-11-00</b>	\$53.95
Fringed	
<b>STR-4NK46-12-00</b>	\$65.95
Studded	
<b>STR-4NK46-13-00</b>	\$65.95

### 5. Leather Backrest Bags

Handcrafted leather bags with Star Concho. Dual mounting straps and double stitching at stress points.

Plain	
<b>STR-4NK47-11-00</b>	\$75.95
Fringed	
<b>STR-4NK47-12-00</b>	\$79.95
Studded	
<b>STR-4NK47-13-00</b>	\$88.95



### 6. Leather Tail Bag

This high-quality, all-leather bag is made to attach quickly to our accessory rear fender rack for over 300 cubic inches of storage. Small zippered pouch on top. Built-in carrying strap. Foam integrated in side panels helps the bag keep its shape even when empty. (11" x 8" x 3")

Studded	
<b>STR-4WM63-10-01</b>	\$214.95

(Plain style shown not available)

### 7. Expandable Tank Bag

Made of tough, water-resistant ballistics nylon. Provides 550 cubic inches of convenient storage for small items for short day trips and quickly expands to over 900 cubic inches when you need the extra room. Embroidered Star logo, five interior pockets, and reversible waterproof map pocket. For carry-away convenience, bag attaches to tank with special, high-strength magnets that are shielded to help protect electronic devices you may be carrying. (11" L x 13" W x 4" H or 7-1/2" expanded)

<b>STR-4WM64-21-00</b>	\$96.95
------------------------	---------



### 8a. Mink Oil

Use to waterproof, preserve, and protect your leather accessories.

4-oz. Jar	
<b>ACC-MINKC-RE-AM</b>	\$2.95

### 8b. Saddle Soap

Use to clean, condition, and restore your leather accessories.

4-oz. Jar	
<b>ACC-SADDL-ES-AP</b>	\$2.95

### 8c. Black Leather Polish

Use to restore black leather to its natural luster by putting color back into the leather.

1.5-oz. Jar	
<b>ACC-CREAM-PL-SH</b>	\$2.49

## 9. Billet Mirrors

Designed to fit a more aggressive personality while maintaining excellent visibility. Available in two head types and three finishes to coordinate with accessory and original equipment components. Smooth and Brushed styles have holes in the stem. Left and right hand mirrors sold separately.

### Oval

Smooth, Left	
<b>STR-5PX13-41-00</b>	\$129.95
Smooth, Right	
<b>STR-5PX13-42-00</b>	\$129.95
Ball Milled, Left	
<b>STR-5PX13-31-00</b>	\$129.95
Ball Milled, Right	
<b>STR-5PX13-32-00</b>	\$129.95
Brushed, Left	
<b>STR-5PX13-61-00</b>	\$129.95
Brushed, Right	
<b>STR-5PX13-62-00</b>	\$129.95

### Tear Drop

Ball Milled, Left	
<b>STR-5PX13-11-00</b>	\$129.95
Ball Milled, Right	
<b>STR-5PX13-12-00</b>	\$129.95
Brushed, Left	
<b>STR-5PX13-51-00</b>	\$129.95
Brushed, Right	
<b>STR-5PX13-52-00</b>	\$129.95



## 10. Billet Mirrors

Each mirror and stem is highly polished and specially treated before chrome plating for an extra-durable finish. Left and right mirrors sold separately.

### Oval

Smooth, Left	
<b>STR-4NK13-41-00</b>	\$118.95
Smooth, Right	
<b>STR-4NK13-42-00</b>	\$118.95
Ball Milled, Left	
<b>STR-4NK13-31-00</b>	\$118.95
Ball Milled, Right	
<b>STR-4NK13-32-00</b>	\$118.95

### Tear Drop

Smooth, Left	
<b>STR-4NK13-21-00</b>	\$118.95
Smooth, Right	
<b>STR-4NK13-22-00</b>	\$118.95
Ball Milled, Left	
<b>STR-4NK13-11-00</b>	\$118.95
(Ball Milled Right not available)	

## 11. Billet Shift Peg Covers

Precisely machined, then highly polished and specially treated for the most durable chrome finish. Metric Allen mounting screws included. (Sold in pairs.)

Ball Milled	
<b>STR-4NK27-13-02</b>	\$49.95





### 1. Billet Brake Pedal Cover

Highly polished and specially treated to provide a rich, durable chrome finish.

**STR-4NK27-12-03** \$48.95

Replacement Rubber

**STR-4NK27-12-98** \$9.95

### 2. Billet Rear Brake Pedal Cover

Unique clamshell design replaces the stock rubber brake pedal cover. Highly polished to provide a durable and rich chrome finish. Machined billet housing with replaceable rubber inserts.

**STR-1D727-12-03** \$86.95

Replacement Rubber Inserts

**STR-1D727-12-98** \$19.95

### 3. Billet Rider Floorboard Covers

These floorboard covers incorporate a molded rubber cushion and ribs for a fresh look and added durability. Highly polished with a rich chrome finish to coordinate with other Star accessories.

**STR-4WM27-11-13** \$279.95

Replacement Rubber, Left

**STR-4WM27-11-21** \$28.95

Replacement Rubber, Right

**STR-4WM27-11-22** \$28.95



### 4. Billet Passenger Floorboards

These passenger floorboards incorporate a molded rubber cushion and ribs for a fresh look and added durability. Highly polished with a rich chrome finish to coordinate with other Star accessories. Requires passenger floorboard mounts (STR-4NK57-40-00) sold separately.

**STR-4WM57-30-01** \$230.95

Replacement Rubber

(Order two if replacing rubber on both boards.)

**STR-4WM57-30-21** \$25.95

### Passenger Floorboard Mounts

(Not shown)

These brackets are specifically designed to allow passenger floorboard installation onto all Royal Star models originally equipped with foot pegs. All hardware is included for easy installation.

Fits '96~'00 Standard models,

'96~'97 Tour Deluxe models

**STR-4NK57-40-00** \$169.99



### 5. Passenger Foot Peg Backing Plate Hole Plugs

Four chrome-plated steel plugs provide a custom, clean solo look. (Backing Plate not included.)

**STR-4NK26-04-04** \$11.95

## 6. Billet Front Axle Bolt Covers

Precisely machined then highly polished and specially treated for the most durable chrome finish. Metric Allen mounting screws included. (Sold in pairs.)

a. Round  
Smooth

STR-4WM27-04-01 \$96.95

Ball Milled

STR-4WM27-04-02 \$96.95

b. Square  
Smooth

STR-4NK27-04-01 \$95.95

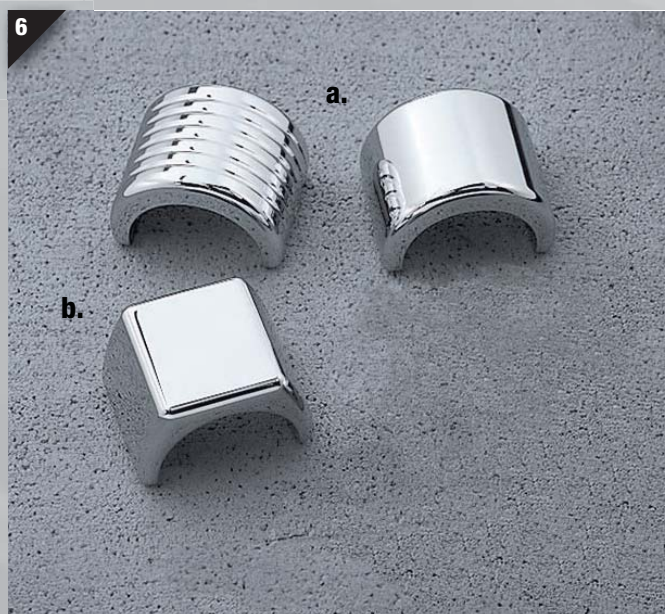

## 7a. Billet Fork Cap Covers

(Sold in pairs.)

Fits '96~'97 Royal Star models

Smooth

STR-4NK27-02-01 \$51.95

Ball Milled

STR-4NK27-02-02 \$51.95

Fits '98~'01 Royal Star models

Ball Milled

STR-5EJ27-02-02 \$52.95

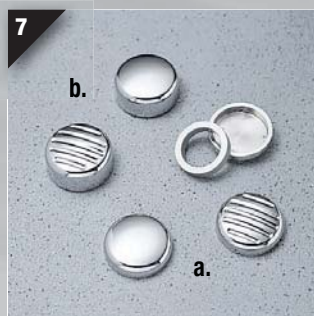

## 7b. Billet Fork Stem Nut Cover

Ball Milled

STR-4NK27-06-02 \$27.95



Royal Star shown with Star Custom Accessories and custom paint.

These accessories fit all '96~'01 Royal Star models unless otherwise noted.



**1. Billet Oil Filler Cap**

Simply replace the stock cap with this brilliant triple-chrome-plated filler cap. Includes O-ring.

**STR-4NK27-14-01**      \$37.95

**2. Billet Rear Fender Hole Plugs**

Use to plug the rear seat mounting bracket holes for a clean and detailed look. O-rings hold each plug in place. (Set of four.)

**STR-4NK27-32-01**      \$32.95

**3. Billet Choke Knob Cover**

Installs in less than a minute with a unique screw-on design.

**STR-4NK27-21-01**      \$43.95



**4. Billet Motor Mount Bolt Covers**

Attach to the motor-mount bolt head to hide the stock washer and provide a personalized chrome touch.

(Sold in pairs.)

Smooth  
**STR-4NK27-18-01**      \$49.95

Ball Milled  
**STR-4NK27-18-02**      \$49.95

### 5. Billet Banjo Joint Covers for Handlebar Reservoirs

This two-piece design set covers the banjo joints that attach to the handlebar reservoirs.

STR-4NK27-22-00 \$96.95

### 6. Billet Wire Harness Guides

Replace the nylon cable-ties with these chrome guides. (Sold in pairs.)

STR-4NK27-62-01 \$70.95

### 7a. Billet Alternator Cover

Simply replaces the stock cover.

Ball Milled

STR-4NK27-44-02 \$80.95

### 7b. Billet Clutch Cover

Adhesive-backed for installation over the stock covers.

Ball Milled

STR-4NK27-43-02 \$77.95

### 8. Billet Carburetor Covers

Includes the left and right carburetor covers and all hardware for easy installation. Ball milled (not available) shown here. (Sold in pairs.)

Smooth

STR-4NK27-42-01 \$91.95

### 9. Chrome Radiator Side Covers

Triple-chrome-plated covers include chrome-plated screws. (Sold in pairs.)

STR-4NK26-10-00 \$129.95

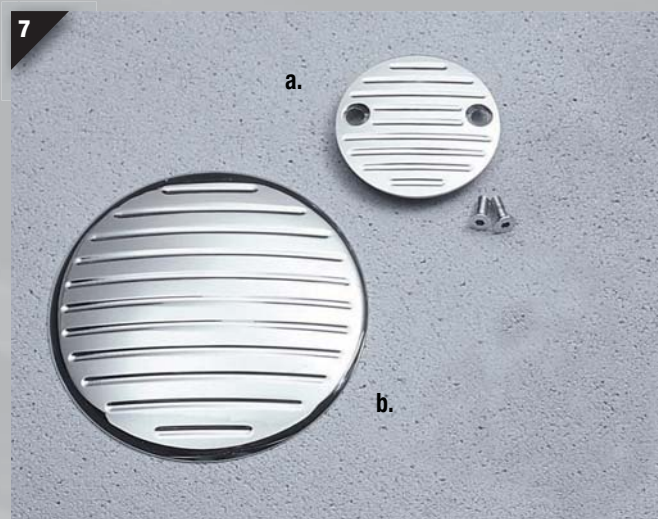



### 1. Chrome Radiator Grille

Easily installs under the radiator side covers to enhance the Royal Star's beauty and to complement other chrome accessories.

**STR-4NK26-12-00** \$150.95



### 3. Chrome Battery Side Covers

Formed steel is highly polished and triple-plated for a brilliant chrome finish. (Sold in pairs.)

**STR-4NK26-30-00** \$208.95



### 4. Chrome Battery Cover Accents

Chrome-plated accent plates provide a personalized look and are easy to install with the adhesive backing. (Sold in pairs.)

**STR-4NK26-20-00** \$52.95



### 2. Chrome Rear Brake Reservoir Cover

Polished and chrome-plated rear brake reservoir cover simply replaces stock cover for a customized look.

**STR-4NK26-13-00** \$34.95

### 5. Chrome Master Cylinder Covers

Attach to the master cylinder reservoirs for a personalized, highly polished, triple-chrome-plated look. (Sold in pairs.)

**STR-4NK18-10-01** \$32.95



### 6. Chrome Allen Bolt Plugs

Nickel-chrome-plated plugs are available in three sizes to fit most of the Allen bolts found on Star models.

5mm (Box of 20)  
**STR-4NK26-01-20** \$12.95

6mm (Box of 10)  
**STR-4NK26-02-10** \$7.95

8mm (Box of 10)  
**STR-4NK26-03-10** \$7.95



### 7. Chrome Engine Bolt Kit

Kit includes 54 smooth Allen bolts to replace the stock bolts on engine side covers, cylinder fins, breather cover, etc.

**STR-4NK88-10-00** \$134.95



### 8. Billet License Plate Frame

Compact billet license frame kit includes all hardware and backing plate.

Smooth

**STR-5PX27-01-01** \$81.95

Brushed

**STR-5PX27-01-07** \$83.95

### 9. Custom License Frames

License frames are available in two styles. The smooth style features a 1/2" round molded edge with clear license cover and chrome backing plate. The ball-milled style features, chrome-plated billet aluminum construction with the Star logo and chrome backing plate. Chrome mounting hardware is included with both styles.

Smooth

**STR-4NK26-25-00** \$59.95

Ball Milled with Logo

**STR-4NK27-01-03** \$96.95

### 10. Chrome Taillight Cover

Details the taillight for a custom look. Adhesive backed for quick and easy installation.

**STR-4NK58-40-00** \$35.95



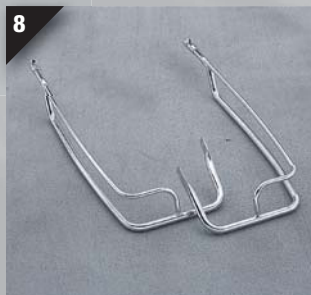

### 1. Chrome Metal Fender Tips

Cast metal fender tips are polished, and then chrome-plated to a brilliant finish for a classic look. (Installation requires drilling of fenders.)

Front of Front Fender

**STR-1D626-90-00** \$70.95

Rear of Front Fender

**STR-1D626-91-00** \$80.95

Rear Fender

**STR-1D626-92-00** \$86.95

### 2. Chrome Fender Tips — Metal

These triple-plated die-cast metal fender tips are the same as the stock fender tips on 2001 Tour Deluxe and Tour Classic models. Drilling of fenders is required.

Front of Front Fender

**STR-4YE26-90-00** \$107.95

Rear of Front Fender

**STR-4YE26-91-00** \$118.95

Rear Fender

**STR-4YE26-92-00** \$118.95

### 3. Chrome Fender Tips — Plastic

Classic fender accents add the look of thick, rich chrome plating. Injected molded design has strong adhesive backing for quick, secure installation.

Front of Front Fender

**STR-4NK26-90-00** \$107.95

Rear of Front Fender

**STR-4NK26-91-00** \$118.95

Rear Fender

**STR-4NK26-92-00** \$118.95

### 4. Front Fender Trim Rail

Classic styling and a brilliant triple-chrome finish enhance the front fender. Not compatible with Chrome Front Fender Tip.

**STR-4XY14-10-00** \$139.95

### 5. Billet Rear Fender Accents

Replaces stock “eyebrows” for a sleek, custom look. (Sold in pairs.)

**STR-4WM27-55-02** \$142.95

### 6. Star Fender Ornament

This rich looking, solid steel, highly polished, triple-plated ornament proudly displays the Star logo.

**STR-4NK14-01-00** \$99.95

### 7. Solo Seat Rail

Styled to complement both stock and Star custom seats, this uniquely designed seat rail is polished and chrome-plated to a show-worthy appearance. Rail is for solo seat application only. (Not compatible with passenger seats.)

**STR-1D624-60-01** \$172.95

### 8. Tour Deluxe Saddlebag Trim Rails

These brilliantly polished and chrome-plated steel trim rails help protect saddlebags, while complementing the smooth lines of the motorcycle. Includes all hardware for easy installation. (Sold in pairs.) Fits '99~'01 Tour Deluxe models

**STR-4XY72-70-00** \$214.95

### 9. Saddlebag Support Bars

Designed to help keep saddlebags off the fender sides and allow clearance for swing arm movement. (Sold in pairs.)

**STR-4NK73-40-00** \$109.95

**10. Road Star Handlebars**

The Road Star handlebars feature wider and lower positioning (3-5/8" rise, 12" pullback, 33-5/8" width.) Not compatible with Tour Classic or Road Star windshields.

**STR-4WM75-13-00** \$75.95

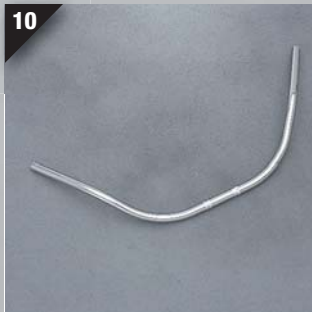
**11. Fat Double "T" Bars**

The Fat Double "T" Bars feature drag-bike styling with stout 1-1/4" diameter tubing swedged down to 1" at the grip area. (6-1/2" rise, 10-1/2" pullback, 34-1/4" width.) Not compatible with Tour Classic or Road Star windshields.

**STR-4NK75-12-00** \$160.95

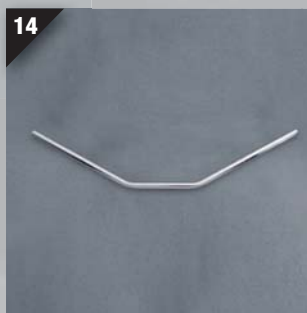
**12. Billet Handlebar Risers**

CNC-machined risers and upper clamp provide 2-1/4" rise and 1-1/4" pullback over the stock risers. (Sold in pairs.)

Smooth

**STR-5PX75-70-01** \$193.95

Brushed

**STR-5PX75-70-07** \$203.95

*NOTE: May require installation of custom cables and hoses depending on the positioning of handlebars being used.*

**Billet Handlebar Risers and Flat Bar**

Designed for the custom drag bike-look, these billet risers and flat bar replace the stock bars and risers. Coordinates with other accessory and stock finishes (when used as a set, bars have 6-1/2" rise, 10-1/4" pullback, 23-3/4" width).

**14. Flat Bars**

**STR-5PX75-14-00** \$69.95

**15. Chrome Grips**

These custom grips include rubber ribs for styling and grip. Attractively priced and easy to install. (Sold in pairs.)

**STR-4NK37-10-11** \$59.95

**13. Handlebar Risers**

Smooth

**STR-5PX75-50-08** \$214.95

Brushed

**STR-5PX75-50-07** \$214.95

**16. Chrome Upper Handlebar Clamps**

These stock upper handlebar clamps are highly polished and brilliantly chrome-plated.

**STR-4NK75-41-00** \$50.95





## Star Custom Accessory Windshields

Our tough polycarbonate windshields not only offer the superior fit and finish you would expect, we went a step further by treating them with the new-generation Quantum™ Coating to provide a long lasting, durable, protective finish. This makes the windscreen three times more scratch-resistant than typical acrylic products, and also much more resistant to damage from bugs, stone chips, road grime, or even everyday cleaning. This extra attention to detail will help keep your windshield looking new longer, and that's a clear benefit you'll enjoy on every ride.

### 1. Tour Classic® Windshields

The Tour Classic Windshield assembly is the same height as the one on the Tour Deluxe model. Replacement windshields are available in Tall, Medium, and Low heights and can be easily mounted onto any of the windshield assemblies for changes in weather or altitude. All windshield assemblies will bolt directly onto the Tour Deluxe and Tour Classic models or the standard Royal Star with mounting hardware.

Windshield Assembly

Tall (23-1/2"\*\*)

**STR-4NL03-10-00** \$379.95

Replacement Windshields

Tall (23-1/2"\*\*)

**STR-4NL03-11-00** \$182.95

Medium (20-1/2"\*\*)

**STR-4NL07-11-00** \$182.95

Low (17-1/2"\*\*)

**STR-4NL06-11-00** \$182.95

Tour Classic Windshield

Mounting Hardware

**STR-4NL03-40-00** \$122.95



### 2. Clear Lower Wind Deflectors

Install these wind deflectors with all Royal Star and Silverado windshields. Requires installation of Tour Classic windshield mounting hardware.

**STR-4NL08-10-00** \$49.95

Lower Deflector Mounting Hardware

**STR-4NL08-40-00** \$116.95

### 3. Billet Lower Wind Deflectors

Mount to the Tour Classic Lower Wind Deflector Mounting Hardware. (Sold in pairs.)

Smooth

**STR-4NL08-20-01** \$129.95

Ball Milled

**STR-4NL08-20-02** \$137.95

Lower Deflector Mounting Hardware

**STR-4NL08-40-00** \$116.95

### 4. Road Star Windshield

Solar-bronze-tinted windshield features traditional styling. The 17-1/2" height\*\* provides upper body wind protection. Mounts allow 2 inch height adjustment. Requires Windshield Mounting Hardware (STR-4NL03-40-00) sold separately.

**STR-4NK06-10-00** \$300.95

Windshield Mounting Hardware

**STR-4NL03-40-00** \$122.95

### 5. Boulevard™ Windshield

Solar bronze-tinted shield provides unique styling and deflects wind from your chest area. Includes triple-plated mounting hardware. (11" tall\*\*)

**STR-4NK05-00-30** \$149.95



\*\*Height measured from top of headlight cutout to top of windshield.

## 6. Passing Lamps

The classic look. Traditional-styled lamps include on/ off switch and wire harness. Choose sealed-beam or halogen (H3) lamps. Order lamps and mounting hardware separately. (Dealer installation recommended.)

Passing Lamps	
Sealed Beam	
<b>STR-4NK35-10-00</b>	\$118.95
Halogen	
<b>STR-4NK35-10-01</b>	\$118.95

Replacement Light Bulb	
Sealed Beam	
<b>STR-4NK35-50-00</b>	\$18.95
Halogen (H3)	
<b>STR-4NK35-50-01</b>	\$18.95
Replacement Lens (H3)	
<b>STR-4NK35-17-01</b>	\$22.95

Passing Lamp Mounts	
<b>STR-4NK35-40-01</b>	\$107.95

## 7. Custom Tri-Bar Headlight

Give your bike a truly custom look by simply replacing your stock headlight with this halogen tri-bar style.

<b>STR-4WM45-10-00</b>	\$106.95
------------------------	----------

## 8. Custom Tri-Bar Passing Lamps

Designed to coordinate with the Tri-Bar Headlight to complete the custom lighting package. Passing lamp mounts required for installation (STR-4NK35-40-01) sold separately.

<b>STR-4WM35-10-EA</b>	\$129.95
Replacement Glass Housing	
<b>STR-4WM35-50-EA</b>	\$32.95

## 9. Visors

Triple-chrome-plated visors include a subtle Star logo.

Headlight Visor	
<b>STR-4NK58-10-00</b>	\$19.95
Passing Light Visors	
<b>STR-4NK58-20-00</b>	\$18.95
Turn Signal Visors	
<b>STR-4NK58-30-00</b>	\$17.95

## 10. Chrome Instrument Visor

Cast metal visor is polished and then chrome-plated to a brilliant finish for a classy look. Adhesive tape included for easy installation.

<b>STR-4NK04-00-00</b>	\$57.95
------------------------	---------



**V Star® 1300 Accessories**

**Comfort Cruise™ Seats**

Comfort Cruise seats offer exceptional riding comfort. Whether you're going across town or across the country, Star Custom Accessories has a seat that is just right for your riding style.

Features include:

- Traditional styling and quality that you have come to expect from all Star Custom accessories
- Luxurious real leather seating panels
- Hand-laid fiberglass seat pan for consistent fit
- Soft foam edges for added comfort and protection for painted surfaces
- Soft foam nose for a close fit to the tank
- A "soft-to-touch" feel along with firmness and support for an all day ride



**1. Comfort Cruise™ Solo Seat**

Our new line of Comfort Cruise seats are developed using the latest pressure mapping technology, include receptacles for our adjustable rider backrest (sold separately) and leather seating panels for added comfort on the long haul  
**STR-3D824-10-01**     \$377.95

**2. Comfort Cruise™ Rider Backrest Pad**

Fits with the V Star 1300 Comfort Cruise Solo seats. Backrest pad features leather contact panel and coordinates with Comfort Cruise Solo Seat. Backrest bracket (STR-3D821-12-00) is required for installation and is sold separately. Not compatible with stock rider seat or passenger seat.  
**STR-3D821-14-00**     \$104.95



**3. Comfort Cruise™ Rider Backrest Plug-In Bracket**  
 Required for installation of Comfort Cruise Rider Backrest Pad on the Comfort Cruise Solo Seat.  
**STR-3D821-12-00**     \$89.95



**4. Comfort Cruise™ Tour Pillion Pad**  
 The Comfort Cruise Tour pillion pad offers a new dimension of passenger comfort. Designed to coordinate with Comfort Cruise Solo Seats to give your bike the right look, with a comfortable feel your passenger will appreciate.  
**STR-3D825-30-01**     \$267.95



### 5. Saddlebags - Hard Leather

Locking saddlebags with premium leather covering. These saddlebags are sculpted to fit the lines of the V Star 1300 with a combined volume of over 2300 cubic inches. These bags are capable of holding a half helmet. Requires installation of mounting hardware (STR-3D873-40-00) sold separately.

Plain  
**STR-3D873-00-00** \$1,168.95

### 6. Saddlebag Mounts

**STR-3D873-40-00** \$150.95

### 7. Hard Saddlebag Liners

Constructed of heavy-duty ballistic nylon for added durability, these saddlebag liners provide carry-away convenience for your luggage. Also features an embroidered Star logo for a quality look and feel. (Sold in pairs.)

**STR-4WM72-90-00** \$86.95

### Quick-Release Passenger Backrest System

This patented, three-piece, quick release system provides an easy-on, easy-off solution to passenger comfort. Polished and chrome-plated sidearms and uprights are sold separately and available in Short and Tall heights. Compatible with Standard and Custom backrest pads (sold separately). Lock kit included with Sidearms to help protect your investment.

### 8. Quick-Release Backrest Sidearms

Polished and chrome-plated sidearms. Requires the use of Quick-Release Backrest Sidearms Hardware Kit (5S7-F84A2-U0-00), sold separately, for installation.

**5S7-F84A0-V0-00** \$259.95

Quick-Release Backrest Sidearms Hardware Kit (Not Shown)  
**5S7-F84A2-U0-00** \$36.95

### 9. Quick-Release Backrest Upright

Polished and chrome plated uprights are available in Short and Tall heights. Designed for use in conjunction with Quick-Release Sidearms and are compatible with Standard and Custom backrest pads (all sold separately).

a. Short  
**5S7-F16C0-V0-00** \$98.95

b. Tall  
**STR-2C541-30-02** \$155.95

### 10. Passenger Backrest Components

A three-piece system with triple-chrome plating. Upright, Sidearm Assembly, and your choice of two backrest pad options.

a. Passenger Backrest Upright  
**STR-3D841-30-02** \$155.95

b. Passenger Backrest Sidearm Assembly  
**STR-3D841-10-00** \$182.95

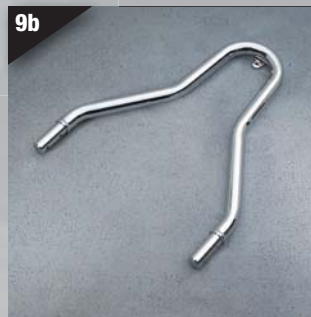

### 11. Passenger Backrest Pads

Backrest pads are constructed of sturdy vinyl and designed to coordinate with V Star 1300 seats.

a. Standard (Coordinates with stock seat)

**STR-3D841-50-00** \$104.95

b. Custom Backrest Pad (Coordinates with Custom Cruise seat)

Plain  
**STR-5GA41-50-00** \$107.95

**Throw-Over Saddlebags**

These handcrafted, throw-over design leather bags feature a plastic base insert and a hard rubber back to help hold the bag's shape when empty. Interior pockets and zippered pouch included. Saddlebag Support Bars (STR-3D873-47-00, sold separately) required for installation.

**1. Star Slant Saddlebags**

(10" x 15-1/2" x 5")

Plain

**STR-4NK73-10-00** \$369.95

Fringed

**STR-4NK73-10-01** \$407.95

Studded

**STR-4NK73-10-02** \$417.95



**2. Classic Deluxe Saddlebags**

(10" x 15-1/2" x 5")

Plain

**ABA-3JK73-00-02** \$343.95

Fringed

**ABA-3JK73-00-00** \$374.95

Studded

**ABA-3JK73-00-01** \$407.95



**3. Classic Saddlebags**

(10" x 12" x 4-1/2")

Plain

**ABA-3JK73-00-04** \$296.95

Fringed

**ABA-3JK73-00-05** \$343.95

Studded

**ABA-3JK73-00-03** \$343.95



**4. Slant Saddlebags**

(10" x 12" x 4-1/2")

Plain

**ABA-3JK73-00-06** \$321.95

Fringed

**ABA-3JK73-00-07** \$353.95

Studded

**ABA-3JK73-00-08** \$386.95



**5. Windshield Bag**

This convenient bag is constructed of premium supple leather and includes special mounting brackets designed to fit all windshields. Twist closure makes access quick and easy.

**5S7-F83G0-V0-00** \$89.95





## 6. Soft Throw-Over Saddlebags

Features include handcrafted leather construction, sturdy zippers, and handles for quick-release convenience. Fastex™ buckles for easy access. Molded ABS back plate with a steel frame to help hold the bag's shape when empty. Requires installation of Saddlebag Support Bars (STR-3D873-47-00), sold separately.

**STR-1D773-55-01** \$369.95

## 7. Leather Tool Bags

Handcrafted leather bags with Star Concho provides both function and style. Dual mounting straps, with double stitching at stress points. (10" x 5" x 3")

Plain

**STR-4NK46-11-00** \$53.95

Fringed

**STR-4NK46-12-00** \$65.95

Studded

**STR-4NK46-13-00** \$65.95

## 8. Saddlebag Support Bars

Designed to help keep saddlebags off the fender and allow clearance for swingarm movement. (Sold in pairs.)

**STR-3D873-47-00** \$105.95

## 9. Billet Brake Pedal Cover

Unique clamshell design replaces the stock rubber brake pedal cover. Highly polished to provide a durable and rich chrome finish. Machined billet housing with replaceable rubber inserts.

**STR-1D727-12-03** \$86.95

Replacement Rubber Inserts

**STR-1D727-12-98** \$19.95

## 10. Billet Rider Floorboard Covers

These floorboard covers have a molded rubber cushion and ribs for a fresh look and added durability. Highly polished with a rich chrome finish to coordinate with other Star accessories. (Sold in pairs.)

**STR-4WM27-11-13** \$279.95

Replacement Rubber, Left

**STR-4WM27-11-21** \$28.95

Replacement Rubber, Right

**STR-4WM27-11-22** \$28.95

## 11. Billet Passenger Floorboards

These passenger floorboards incorporate a molded rubber cushion and ribs for a fresh look and added durability. Highly polished with a rich chrome finish to coordinate with other Star accessories. Requires passenger floorboard mounts (STR-3D857-40-01) for installation.

**STR-4WM57-30-01** \$230.95

Replacement Rubber

(Order two if replacing rubber on both boards.)

**STR-4WM57-30-21** \$25.95

## 12. Passenger Floorboards

Cast aluminum floorboards with rubber inserts designed to coordinate with the stock rider floorboards. Requires passenger floorboard mounts (STR-3D857-40-01) for installation. (Sold in pairs.)

**STR-4YE57-20-02** \$150.95

Replacement Rubber Inserts

(Order two if replacing rubber on both boards.)

**4YE-27433-00-00** \$11.95

## 13. Passenger Floorboard Mounts

**STR-3D857-40-01** \$89.95

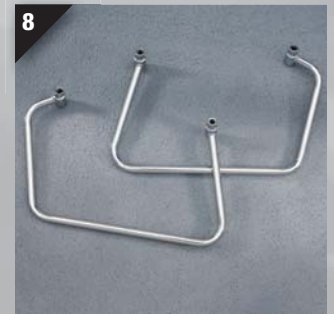

These accessories fit all V Star 1300 models unless otherwise noted.

### 1. Chrome Fender Tips

Cast metal fender tips are polished and then chrome-plated to a brilliant finish for a modern classic look. (Installation requires drilling of fenders.)

- a. Front of Front Fender  
**STR-3D826-90-00**     \$65.95
- b. Rear of Front Fender  
**STR-3D826-91-00**     \$80.95
- c. Rear of Rear Fender  
**STR-3D826-92-00**     \$97.95



### 2. Chrome Upper Belt Guard

Stock belt guard, highly polished, and chrome-plated. Set includes upper belt guard and lower accent.

- STR-3D885-10-01**     \$97.95



### 3. Billet Drive Pulley Cover Set

Precision-machined from billet aluminum. This case set replaces the existing front pulley cover, leaving the pulley visible. Kit includes chrome-plated billet pulley insert and chrome hardware that will give your bike a show-worthy appearance.

- Ball Milled  
**STR-3D827-82-01**     \$467.95





#### 4. Billet Frame Inserts

These inserts attach next to the steering head cover using enclosed hardware for a clean, custom look. Precision machined and finished to coordinate with other V Star accessories.

Smooth  
**STR-3D827-58-01** \$99.95

#### 5. Billet Right Hand Small Engine Cover Insert

Ball Milled  
**STR-3D827-44-01** \$65.95

#### 6. Billet Pulley Cover Insert

Ball Milled  
**STR-3D827-81-01** \$89.95

#### 7. Billet Clutch Cover Insert

Ball Milled  
**STR-3D827-43-01** \$104.95

#### 8. Billet Generator Cover Insert

Ball Milled  
**STR-3D827-41-01** \$104.95

#### 9. Billet Rear Axle Covers

Cool billet covers complement the stylish swingarm. Requires removal of rear axle. (Dealer installation recommended.)

Smooth  
**STR-3D827-57-01** \$167.95

#### 10. Billet Front Axle Bolt Covers

Precisely machined, then highly polished and specially treated for the most durable chrome finish. Metric Allen mounting screws included. (Sold in pairs.)

**a. Round**  
Smooth  
**STR-4WM27-04-01** \$96.95  
Ball Milled  
**STR-4WM27-04-02** \$96.95

**b. Square**  
Smooth  
**STR-4NK27-04-01** \$95.95

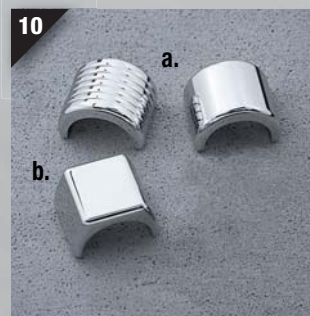



## Star Custom Accessory Windshields

Star Custom Accessories offer advantages and features that add to their value. Our windshields, for example, not only offer the superior fit and finish you would expect, we went a step further by using a hard-coated polycarbonate windscreen material. This makes the windscreen three times more scratch-resistant than typical acrylic products, and also much more resistant to damage from bugs, stone chips, road grime, or even everyday cleaning. This extra attention to detail will help keep your windshield looking new longer, and that's a clear benefit you'll enjoy on every ride.

### 1. Windshield Assembly

Windshield assemblies are available in three heights\*\*: Tall (23-1/4" the same height as the standard Tourer), Medium (19") and Short (15"). Replacement windshields are also available in Tall, Medium, and Short height, making it easy to change your windshield to match changes in weather or attitude. All windshield assemblies will bolt directly onto the Tourer model or, with Windshield Mounts, onto the standard V Star 1300.

Tall	
<b>STR-3D803-10-00</b>	\$363.95
Medium	
<b>STR-3D807-10-00</b>	\$363.95
Short	
<b>STR-3D806-10-00</b>	\$363.95

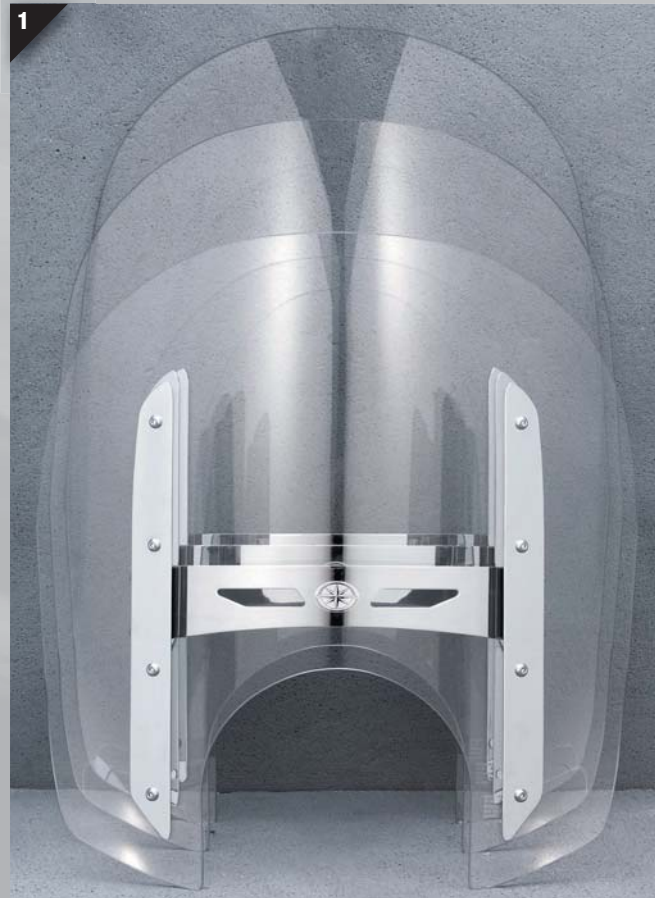

Replacement Windshield (Not shown)	
Tall (23-1/4"**)	
<b>STR-3D803-11-00</b>	\$209.95
Medium (19"**)	
<b>STR-3D807-11-00</b>	\$209.95
Short (15"**)	
<b>STR-3D806-11-00</b>	\$209.95

Windshield Mounts (Not Shown)	
<b>STR-3D803-40-00</b>	\$107.95

### 2. Quick-Release Windshield Mount Retro-Fit Kit

Converts standard fixed windshield on V Star 1300 Tourer model to the Quick-Release type.

<b>5S7-F83L0-U0-00</b>	\$312.95
------------------------	----------



### 3. Passing Lamp Mount

A modern look for a classic accessory. This new mount is die cast, polished, and chrome plated to complement the style of the bike. Order Sealed Beam, Halogen, or Tri-Bar Passing Lamp separately.

**STR-3D835-40-00** \$178.95

### 4. Passing Lamps

The classic look. Traditional-styled lamps include on/ off switch and wire harness. Choose sealed-beam or halogen (H3) lamps. Order lamps and mounting hardware separately. (Dealer installation recommended)

a. Sealed Beam

**STR-4NK35-10-00** \$118.95

b. Halogen

**STR-4NK35-10-01** \$118.95

### Replacement Light Bulb

Sealed Beam

**STR-4NK35-50-00** \$18.95

Halogen (H3)

**STR-4NK35-50-01** \$18.95

Replacement Lens (H3)

**STR-4NK35-17-01** \$22.95

### 5. Custom Tri-Bar Passing Lamps

Coordinates with the stock headlight to complete the custom look. Passing Lamp Mount (STR-3D835-40-00, sold separately) required for installation.

**STR-4WM35-10-EA** \$129.95

Replacement Glass Housing

**STR-4WM35-50-EA** \$32.95

### 6. Billet Rear Fender Rack

A new twist on an old standard. This rear fender rack is machined out of 6061 billet aluminum, and then polished and chrome-plated. For use with solo seat only; not compatible with passenger seats.

**STR-3D851-40-00** \$157.95

### 7. Rear Luggage Rack

Attaches to the stock Tourer backrest or the accessory Passenger Backrest (sold separately).

**STR-3D851-30-00** \$152.95

### 8. Rear Luggage Rack

This rack is designed to be used in conjunction with the Quick-Release Passenger Backrest System (see page 8-99 for components).

**STR-2C551-30-00** \$113.95

### 9. Wide Handlebars

These wide bars are all about attitude with a low, wide stance (3-5/8" rise, 12-1/16" pullback, 33-5/8" width).

**STR-3D875-13-00** \$96.95

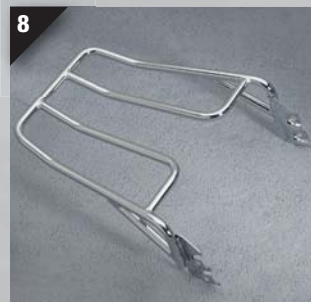

These accessories fit all V Star 1300 models unless otherwise noted.  
\*\*Height measured from top of headlight cutout to top of windshield.

### 1. Big Bar Engine Guards

The ultimate in classic styling. The big 1-1/4" tubing matches the styling of the V Star 1300.

**STR-3D831-20-00** \$193.95

#### **⚠ WARNING**

These engine guards may provide limited protection against cosmetic vehicle damage in certain situations, such as if the motorcycle tips over while stopped or moving slowly. These engine guards are not manufactured or intended to protect the rider from injury in a collision.

### 2. Saddlebag Guards

Polished and chrome-plated for style and function. Help protect Tourer saddlebags if your bike is dropped. Saddlebag Mounts (STR-3D873-40-00) required for mounting on standard V Star 1300.

**STR-3D833-00-00** \$299.95

### 3. Saddlebag Trim Rails

These polished and chrome-plated trim rails wrap around the Tourer Saddlebags adding to the flowing lines of the motorcycle. Requires Saddlebag Mounts and Guards for installation.

**STR-3D872-70-00** \$214.95

### 4. Front Fender Trim Rail

Modern classic design specifically styled to coordinate with the flowing lines of the V Star 1300. (Not compatible with front fender tip.)

**STR-3D814-10-00** \$225.95



**5. Billet Wire  
Harness Guides**

Replace the nylon cable-ties with these chrome guides. (Sold in pairs.)  
STR-4NK27-62-01 \$70.95

**6. Billet Banjo Joint  
Covers**

Two-piece set to cover the bolt head on the front brake caliper banjo-joint bolts.  
STR-4WM27-23-01 \$29.95

**7. Billet Caliper  
Bleeder Covers**

Use to enhance the brake caliper bleeder for a detailed look.  
STR-4WM27-29-01 \$35.95

**8. Billet Fork Cap Covers**

Precisely machined then highly polished and treated for durable chrome finish. Available in smooth and ball-milled finishes.  
Smooth  
STR-4YV27-02-01 \$45.95

**9. Chrome Allen Bolt Plugs**

Nickel-chrome-plated plugs are available in three sizes to fit most of the Allen bolts found on all Star models.

5mm (Box of 20)  
STR-4NK26-01-20 \$12.95  
6mm (Box of 10)  
STR-4NK26-02-10 \$7.95  
8mm (Box of 10)  
STR-4NK26-03-10 \$7.95

**10. Billet Oil Filler Cap**

Simply replace the stock cap with this brilliant triple-chrome-plated filler cap. Includes O-ring.  
STR-5BN27-14-01 \$41.95

**11. Speedstar® Competition Long Drag Exhaust System**

Designed to maximize exhaust flow for increased performance, with more mid-range torque and higher overall power. This system features 1-3/4" header pipe with 2-3/8" outer pipe heat shields. Heat shields are constructed of heavy-gauge steel and then polished and richly chrome-plated for an extra-durable, shiny finish. Baffles are non-removable. Comes complete with mounting bracket and hardware.  
SPD-3D809-90-02 \$699.95  
*For closed-course use only (see Important Note).*

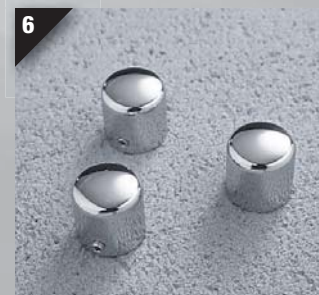
**Important Note:**

All Star models are regulated by the EPA and state law. This accessory affects emissions and is for closed-course competition only. Use on public roads constitutes illegal tampering punishable by law.

These accessories fit all V Star 1300 models unless otherwise noted.

## 1. Billet License Plate Frame

Compact billet license frame kit includes all hardware and backing plate.

Smooth

**STR-5PX27-01-01** \$81.95

Brushed

**STR-5PX27-01-07** \$83.95

## 2. Custom License Frames

License frames are available in two finishes. The smooth style features a 1/2" round molded edge with clear license cover and chrome backing plate. The ball-milled style features chrome-plated billet-aluminum construction with the Star logo and chrome backing plate. Chrome mounting hardware is included with both styles.

Smooth

**STR-4NK26-25-00** \$59.95

Ball Milled with Logo

**STR-4NK27-01-03** \$96.95

## 3. Star Fender Ornament

This rich looking, solid steel, highly polished, triple-plated ornament proudly displays the Star logo.

**STR-4NK14-01-00** \$99.95

## 4. Expandable Custom Cover

This unique and versatile cover incorporates expandable windshield and backrest pockets to accommodate everything from a stock V Star 1300 to a fully accessorized Tourer, yet maintains that custom-fit look. The top half uses premium Evolution® IV fabric that is breathable, water repellent and UV-resistant. The bottom half is constructed of duck canvas for heat protection against exhaust pipes. Both materials provide excellent outdoor protection. (Not recommended for trailering.)

**STR-4WMCU-SC-VR** \$134.95

## 5. Dust Cover

Great for protecting your Star in wind-protected places such as a garage. The machine-washable knit polyester fabric will not scratch paint, windshield, or chrome.

**STR-4WMDS-TC-VR** \$75.95



These accessories fit all V Star 1300 models unless otherwise noted.

**V Star® 950 Accessories****Comfort Cruise™ Seats**

The Comfort Cruise seats are developed using the latest pressure-mapping technology to offer a new dimension of riding comfort. Whether you're going across town or across the country, Star Custom Accessories has a seat that is just right for your riding style.

**1. Comfort Cruise™ Dual Touring Seat**

This Comfort Cruise Dual Touring Seat combines the comfort of a touring bike with the styling of a custom. With sculpted seating positions and leather seating panels, this seat delivers maximum comfort.

**5S7-F47C0-U0-00** \$469.95

**2. Comfort Cruise™ Stiletto Seat**

This Comfort Cruise Stiletto seat has an aggressive low-slung design that offers comfort to go the miles.

**5S7-F47C0-T0-00** \$356.95

**3. Comfort Cruise™ Solo Seat**

This Comfort Cruise Solo Seat offers a new dimension of rider comfort. Leather seating panels provided added comfort on the long haul. Not compatible with stock pillion pad.

**5S7-F47C0-V0-00** \$299.95

**4. Comfort Cruise™ Tour Pillion Pad**

The Comfort Cruise Tour Pillion Pad offers a new dimension of passenger comfort. Designed to coordinate with the Comfort Cruise Solo Seat to give your bike the right look, with a comfortable feel your passenger will appreciate. Not compatible with stock rider seat.

**5S7-F47E0-V0-00** \$229.95

**Quick-Release Passenger Backrest System**

This patented, three-piece, quick release system provides an easy-on, easy-off solution to passenger comfort. Polished and chrome-plated sidearms and uprights are sold separately and available in Short and Tall heights. Compatible with Standard and Custom backrest pads (sold separately). Lock kit included with sidearms to help protect your investment.

**5. Quick-Release Backrest Sidearms**

Polished and chrome-plated sidearms. Requires the use of Quick-Release Backrest Sidearms Hardware Kit (5S7-F84A2-U0-00), sold separately, for installation.

**5S7-F84A0-V0-00** \$259.95

**Quick-Release Backrest Sidearms Hardware Kit (Not Shown)**

**5S7-F84A2-U0-00** \$36.95

**6. Quick-Release Backrest Upright**

Polished and chrome plated uprights are available in Short and Tall heights. Designed for use in conjunction with Quick-Release Sidearms and are compatible with Standard and Custom backrest pads (all sold separately).

**a. Short**  
**5S7-F16C0-V0-00** \$98.95

**b. Tall**  
**STR-2C541-30-02** \$155.95

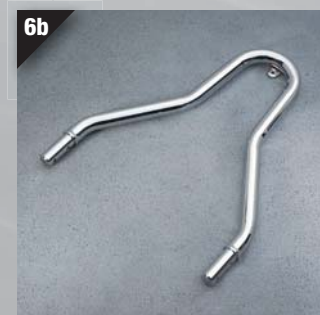

These accessories fit all V Star 950 models unless otherwise noted.

**1. Passenger Backrest Pads**

These backrest pads are compatible with the Quick-Release Passenger Backrest components and/or can be installed on the stock passenger backrest on the V Star 950 Tourer model.

- a. Standard  
**STR-3D841-50-00**      \$104.95
- b. Custom  
**STR-5GA41-50-00**      \$107.95



**2. Saddlebags - Hard Leather**

Locking saddlebags with premium leather covering. These saddlebags are sculpted to fit the lines of the V Star 950 with a combined volume of over 2300 cubic inches. These bags are capable of holding a half helmet. Requires installation of saddlebag mounts (5S7-F84G0-V0-00) sold separately.

- Plain  
**5S7-F84H0-V0-00**      \$999.95

- Saddlebag Mounts  
(Not shown)  
**5S7-F84G0-V0-00**      \$154.95



**3. Hard Saddlebag Liners**

Constructed of heavy-duty ballistic nylon for added durability, these saddlebag liners provide carry-away convenience for your luggage. Also features an embroidered Star logo for a quality look and feel. (Sold in pairs.)

- STR-4WM72-90-00**      \$86.95



**Throw-Over Saddlebags**

These handcrafted, throw-over design leather bags feature a plastic base insert and a hard rubber back to help hold the bag's shape when empty. Interior pockets and zippered pouch included. Saddlebag Support Bars (STR-3D873-47-00, sold separately) required for installation.

**4. Star Slant Saddlebags**

(10" x 15-1/2" x 5")

Plain

STR-4NK73-10-00 \$369.95

Fringed

STR-4NK73-10-01 \$407.95

Studded

STR-4NK73-10-02 \$417.95

**5. Classic Deluxe Saddlebags**

(10" x 15-1/2" x 5")

Plain

ABA-3JK73-00-02 \$343.95

Fringed

ABA-3JK73-00-00 \$374.95

Studded

ABA-3JK73-00-01 \$407.95

**6. Classic Saddlebags**

(10" x 12" x 4-1/2")

Plain

ABA-3JK73-00-04 \$296.95

Fringed

ABA-3JK73-00-05 \$343.95

Studded

ABA-3JK73-00-03 \$343.95

**7. Slant Saddlebags**

(10" x 12" x 4-1/2")

Plain

ABA-3JK73-00-06 \$321.95

Fringed

ABA-3JK73-00-07 \$353.95

Studded

ABA-3JK73-00-08 \$386.95

**8. Soft Throw-Over Saddlebags**

Features include handcrafted leather construction, sturdy zippers, and handles for quick-release convenience. Fastex® buckles for easy access. Molded ABS back plate with a steel frame to help hold the bag's shape when empty. Requires installation of Saddlebag Support Bars (557-F84M0-V0-00), sold separately.

STR-1D773-55-01 \$369.95

**9. Leather Tool Bags**

Handcrafted leather bags with Star Concho provides both function and style. Dual mounting straps, with double stitching at stress points. (10" x 5" x 3")

Plain

STR-4NK46-11-00 \$53.95

Fringed

STR-4NK46-12-00 \$65.95

Studded

STR-4NK46-13-00 \$65.95

**10. Windshield Bag**

This convenient bag is constructed of premium supple leather and includes special mounting brackets designed to fit all V Star 950 windshields. Twist closure makes access quick and easy.

5S7-F83G0-V0-00 \$89.95





### 1. Billet Brake Pedal Cover

Unique clamshell design replaces the stock rubber brake pedal cover. Highly polished to provide a durable and rich chrome finish. Machined billet housing with replaceable rubber inserts.

**STR-1D727-12-03** \$86.95

Replacement Rubber Inserts

**STR-1D727-12-98** \$19.95

### 2. Billet Rider Floorboard Covers

These floorboard covers have a molded rubber cushion and ribs for a fresh look and added durability. Highly polished with a rich chrome finish to coordinate with other Star accessories. (Sold in pairs.)

**STR-4WM27-11-13** \$279.95

Replacement Rubber, Left

**STR-4WM27-11-21** \$28.95

Replacement Rubber, Right

**STR-4WM27-11-22** \$28.95

### 3. Billet Passenger Floorboards

These passenger floorboards incorporate a molded rubber cushion and ribs for a fresh look and added durability. Highly polished with a rich chrome finish to coordinate with other Star accessories. Requires passenger floorboard mounts (5S7-F47D0-V0-00) for installation.

**STR-4WM57-30-01** \$230.95

Replacement Rubber  
(Order two if replacing rubber on both boards.)

**STR-4WM57-30-21** \$25.95

### 4. Passenger Floorboards

Cast aluminum floorboards with rubber inserts designed to coordinate with the stock rider floorboards. Requires passenger floorboard mounts (5S7-F47D0-V0-00) for installation. (Sold in pairs.)

**STR-4YE57-20-02** \$150.95

Replacement Rubber Inserts  
(Order two if replacing rubber on both boards)

**4YE-27433-00-00** \$11.95

### 5. Passenger Floorboard Mounts

Required for installing the accessory passenger floorboards on the V Star 950. Mount Adaptor Plates also required unless the hard saddlebags (5S7-F84H0-V0-00) are installed.

a. Passenger Floorboard Mounts  
**5S7-F47D0-V0-00** \$89.95

b. Mount Adaptor Plates  
**5S7-F47D0-U0-00** \$41.95



## JEFF PALHEGYI SIGNATURE SERIES - custom accessories from one of today's top bike builders

Bike builder Jeff Palhegyi is the architect of many of the most admired customized Star motorcycles ever crafted. His creative work has appeared in top motorcycle shows and has been frequently featured in Custom Star calendars. Those lucky enough to own a motorcycle from Palhegyi Designs can count on attracting plenty of attention. Palhegyi's talent and creative vision have earned him recognition as one of the world's top custom bike designers. His artistry has been acknowledged in over 40 articles in national magazines, and he has made many TV appearances, including documentaries on SPEED TV ("V-Twin TV" and "Epic Rides"). Palhegyi customs have also been showcased in the IMS Tour in the United States, the Tokyo Motor Show in Japan, and the INTERMOT® and Milan shows in Europe.



### Custom "Bomber" Components

Jeff Palhegyi has designed these custom Bomber-series components exclusively for Star Motorcycles. Bomber covers are available either polished and plated to a show-quality chrome finish or in the "Midnight" collection for a blacked-out look detailed with brushed fin edges. Bomber components have a coordinated look to give your V Star 950 a true custom look.

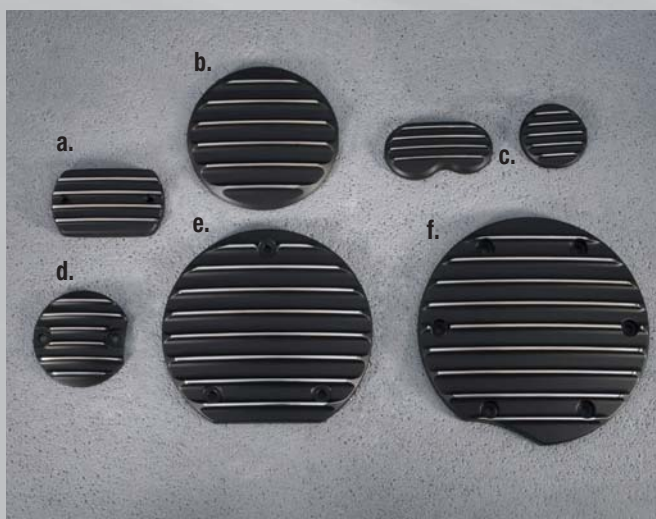

Midnight Bomber Components

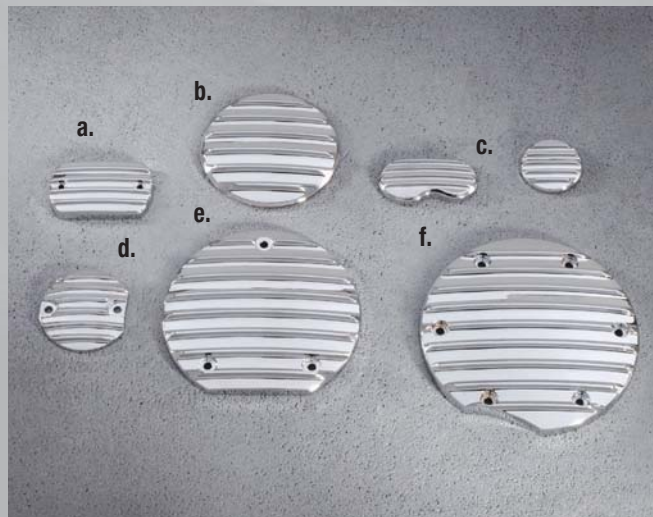

### Chrome Bomber Components

#### a. Master Cylinder Cover

This custom designed cover cleanly hides the front master cylinder. Chrome hardware included for easy installation.

Chrome	
<b>5S7-F58D0-V0-00</b>	\$44.95
Midnight	
<b>5S7-F58D0-U0-00</b>	\$44.95

#### b. Pulley Cover Insert

Replaces stock drive pulley cover insert.

Chrome	
<b>5S7-E54D0-V0-00</b>	\$79.95
Midnight	
<b>5S7-E54D0-U0-00</b>	\$75.95

#### c. Caliper Covers

Adhesive-backed for quick and easy installation. (Three-piece set covers front and rear calipers.)

Chrome	
<b>5S7-F58B0-V0-00</b>	\$69.95
Midnight	
<b>5S7-F58B0-U0-00</b>	\$66.95

#### d. Right-Hand Small Engine Cover Insert

Replaces stock right-hand engine cover insert.

Chrome	
<b>5S7-E54B0-V0-00</b>	\$35.95
Midnight	
<b>5S7-E54B0-U0-00</b>	\$35.95

#### e. Clutch Cover Insert

Replaces stock clutch cover insert.

Chrome	
<b>5S7-E54E0-V0-00</b>	\$109.95
Midnight	
<b>5S7-E54E0-U0-00</b>	\$104.95

#### f. Generator Cover Insert

Replaces stock generator cover insert.

Chrome	
<b>5S7-E54A0-V0-00</b>	\$99.95
Midnight	
<b>5S7-E54A0-U0-00</b>	\$97.95



These accessories fit all V Star 950 models unless otherwise noted.

**1. Chrome Fender Tips Set**

These fender tips are chrome-plated to a brilliant finish for a classic look. The ABS, adhesive-backed design allows for easy application and eliminates fender drilling. Includes front and rear of front fender and rear of rear fender.

**5S7-F15C0-T0-00** \$91.95



**2. Chrome Front Fender Trim Rail**

Classic styling and a brilliant triple-chrome-plated finish enhance the look of the front fender.

**5S7-F15B0-V0-00** \$119.95



**3. Chrome Battery Side Covers**

Personalize the look of your V Star 950 by replacing the stock painted covers with these chrome-plated covers. (Two-cover set.)

**5S7-F17B0-U0-00** \$79.95



**4. Chrome Side Cover – Lower**

Personalize the look of your V Star 950 by replacing the stock painted cover with this chrome-plated plastic cover.

**5S7-F17B0-T0-00** \$61.95



**5. Chrome Upper Belt Guard**

Stock belt guard, highly polished, and chrome-plated. Set includes upper belt guard and lower accent.

**STR-3D885-10-01** \$97.95

**6. Billet Wire Harness Guides**

Replace the nylon cable-ties with these chrome guides. (Sold in pairs.)

**STR-4NK27-62-01** \$70.95

**7. Chrome Allen Bolt Plugs**

Nickel-chrome-plated plugs are available in three sizes to fit most of the Allen bolts found on all Star models.

5mm (Box of 20)  
**STR-4NK26-01-20** \$12.95

6mm (Box of 10)  
**STR-4NK26-02-10** \$7.95

8mm (Box of 10)  
**STR-4NK26-03-10** \$7.95

**8. Billet Oil Filler Cap**

Simply replace the stock cap with this brilliant triple-chrome-plated filler cap. Includes O-ring.

**STR-5BN27-14-01** \$41.95

**9. Mini Tank Cover**

This soft leather mini cover simply attaches to the fuel tank. Looks good and helps protect the paint from scuffs and pant leg wear.

**5S7-F41B0-V0-00** \$49.95

## 10. Boulevard™ Windshield

This 8-3/8" high\*\* windscreen is made of tough polycarbonate with new generation Quantum™ Coating. Smoked shield and chrome-plated trim provides unique styling while deflecting wind from your chest area. Includes polished stainless steel mounting hardware.

**5S7-F83J0-S0-00** \$199.95

## 11. Quick-Release Windshields

Made of tough 4.5mm thick polycarbonate treated with the new generation Quantum™ Coating to provide a long lasting, durable protective finish. The unique patented quick-release feature allows for quick change of your windshield before riding, due to a change in weather or attitude. A lock is included for added security. Replacement windscreens are also available in all three heights and also fit standard Tourer model windshield. Windshield mounts sold separately.

Windshield Assembly  
Tall (24-3/4"\*\*) \$379.95

**5S7-F83J0-V0-00** \$379.95

Medium (20-1/2"\*\*) \$372.95

**5SJ-F83J0-U0-00** \$372.95

Short (16-3/8"\*\*) \$359.95

**5SJ-F83J0-T0-00** \$359.95

Replacement Windshield

Tall (24-3/4"\*\*) \$164.95

**5S7-F83H0-V0-00** \$164.95

Medium (20-1/2"\*\*) \$154.95

**5S7-F83H0-U0-00** \$154.95

Short (16-3/8"\*\*) \$144.95

**5S7-F83H0-T0-00** \$144.95

## 12. Quick-Release Windshield Mounts

Required for installation of Quick-Release Windshields on V Star 950 standard model.

**5S7-F83L0-V0-00** \$177.95

## 13. Quick-Release Windshield Mount Retro-Fit Kit

Converts standard fixed windshield on V Star 950 Tourer model to the Quick-Release type.

**5S7-F83L0-U0-00** \$312.95

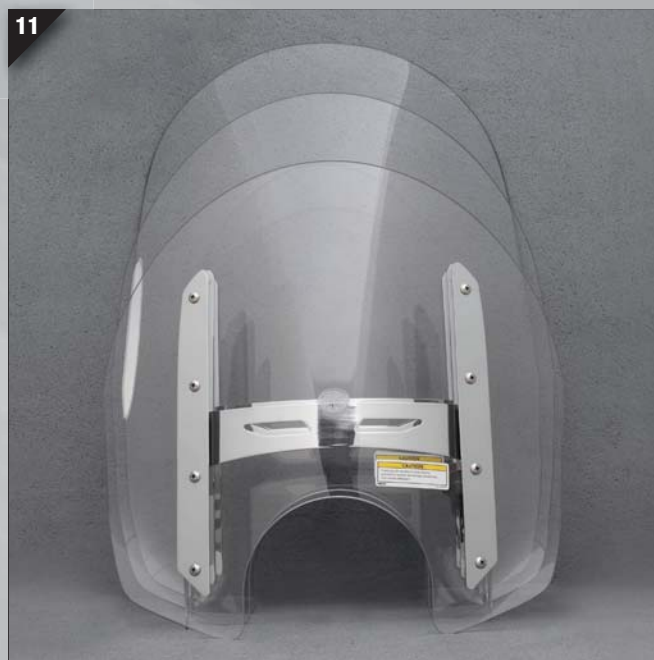
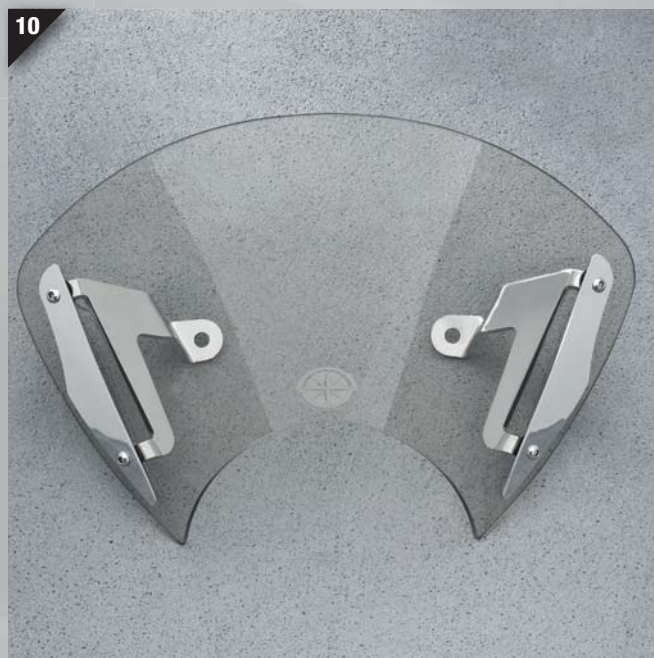

These accessories fit all V Star 950 models unless otherwise noted.  
\*\*Height measured from top of headlight cutout to top of windshield.



### 1. Passing Lamps Kit

A modern look for a classic accessory. This new mount is die cast, polished and chrome plated to complement the style of the bike. The traditional style H3 halogen lamps include a handlebar-mounted on/off switch and wire harness. (Dealer installation recommended).  
**5S7-H54A0-U0-00** \$309.95

**NEW!** Replacement Bulb (Not shown)  
**STR-4NK35-50-01** \$18.95

### 2. Headlight Body

A triple-plated and brilliantly polished headlight housing to replace the stock component.  
**5S7-H43B0-V0-00** \$84.95

### 3. Wide Handlebars\*\*\*

These wide bars are all about attitude with a low, wide stance (3-5/8" rise, 12-1/16" pullback, 33-5/8" width). Use the Billet Wire Harness Guides shown on page 8-114 for best appearance.  
**5S7-F61B0-U0-00** \$89.95

### 4. Handlebar Crown

A triple-plated and brilliantly polished crown to replace the stock component. A perfect compliment to the accessory Wide Handlebars and braided stainless steel lines and cables. (Dealer installation recommended.)  
**5S7-F34C0-V0-00** \$169.95

### 5. Handlebar Holder

A triple-plated and brilliantly polished handlebar holder replaces stock and adds a custom look to the bars. A perfect complement to the accessory Wide Handlebars and braided stainless steel lines and cables.  
**5S7-F34D0-V0-00** \$149.95



\*\*\*Requires installation of the braided stainless steel throttle cable, clutch cable, and front brake line (see page 8-118).

**6. Big Bar Engine Guards**

The ultimate in classic styling. The big 1-1/4" tubing matches the styling of the V Star 950.

**5S7-F43B0-V0-00** \$179.95

**⚠ WARNING**

These engine guards may provide limited protection against cosmetic vehicle damage in certain situations, such as if the motorcycle tips over while stopped or moving slowly. These engine guards are not manufactured or intended to protect the rider from injury in a collision.

**7. Saddlebag Guards**

Polished and chrome-plated for style and function. Help protect saddlebags if your bike is dropped. Saddlebag Mounts (5S7-F84G0-V0-00) required for mounting on V Star 950 standard model.

**5S7-F84D0-V0-00** \$299.95

**8. Saddlebag Trim Rails**

These polished and chrome-plated trim rails wrap around the Tourer Saddlebags adding to the flowing lines of the motorcycle. Requires Saddlebag Mounts (5S7-F84G0-V0-00) and Guards (5S7-F84D0-V0-00), both sold separately, for installation.  
**STR-3D872-70-00** \$214.95

**9. Saddlebag Support Bars**

Designed to help keep saddlebags off the fender sides and allow clearance for swing arm movement. (Sold in pairs.)

**5S7-F84M0-V0-00** \$119.95

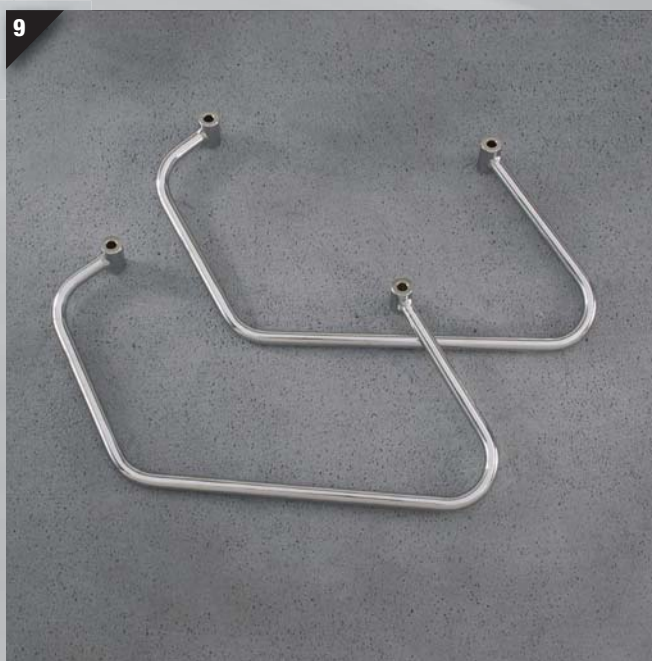
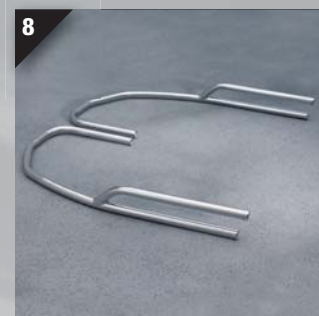
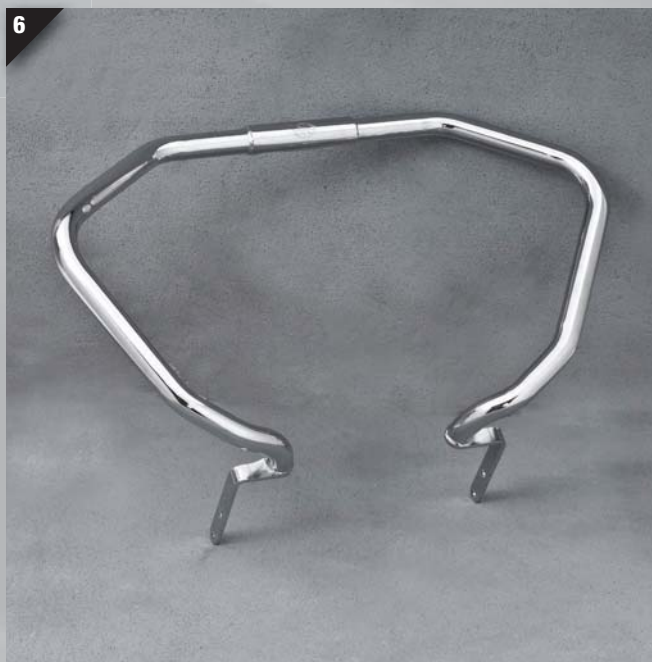



### 1. Rear Luggage Rack

Polished and chrome plated tubular design complements the overall style of the V Star 950 while providing a convenient place to carry luggage. Available for both the Quick-Release Passenger Backrest System (see page 8-109) and the standard backrest on the Tourer model. Quick-Release Backrest Luggage Rack

<b>STR-2C551-30-00</b>	\$113.95
Tourer Backrest Luggage Rack	
Requires Tourer Adaptor Kit (5S7-F48B2-T0-00), sold separately.	
<b>STR-3D851-30-00</b>	\$152.95
Tourer Adaptor Kit	
<b>5S7-F48B2-T0-00</b>	\$22.50

### 2. Billet Rear Fender Rack

A new twist on an old standard. This rear fender rack is machined out of 6061-billet aluminum then polished and chrome-plated. Not compatible with passenger seat.

<b>STR-1D751-40-00</b>	\$166.95
------------------------	----------

### 3. Braided Stainless Steel Cables

Upgrade the appearance of your V Star 950 by replacing the stock black cables with these stainless steel braided cables built to exacting stock specifications. Nylon inner liner for smooth operation. Cable has a rugged clear coat on its full length to make it easier to clean, while helping to protect windshields and painted surfaces. (Dealer installation recommended.)

Throttle Cables*	
<b>5S7-F63B0-V0-00</b>	\$87.95
Clutch Cable*	
<b>5S7-F63A0-V0-00</b>	\$65.95

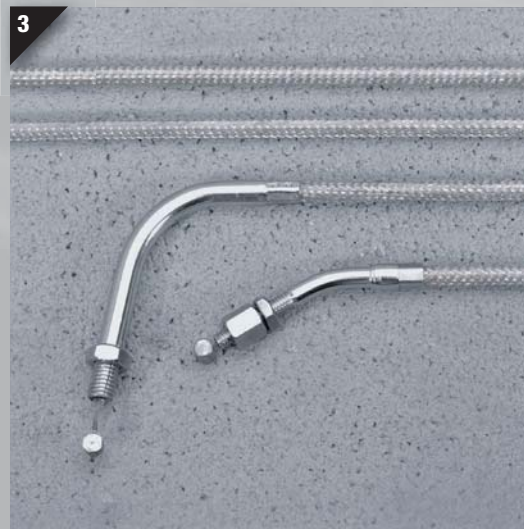

### 4. Braided Stainless Steel Brake Lines

All of our hydraulic lines are constructed using 308 stainless steel braided brake hose with a Teflon® inner liner. Brake lines have a rugged clear coat on their full length to make them easier to clean, while helping to protect windshields and painted surfaces. (Dealer installation recommended.)

Front	
<b>5S7-F58E0-V0-00</b>	\$79.95
Rear	
<b>5S7-F58A0-V0-00</b>	\$49.95

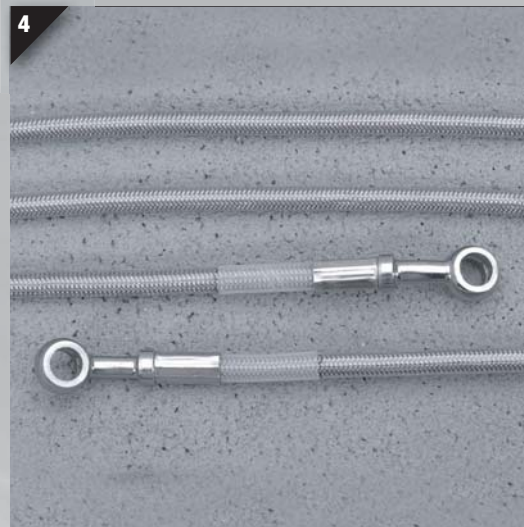

## 5. Billet License Plate Frame

Compact billet license frame kit includes all hardware and backing plate.

Smooth

**STR-5PX27-01-01** \$81.95

Brushed

**STR-5PX27-01-07** \$83.95

## 6. Custom License Frames

License frames are available in two finishes. The smooth style features a 1/2" round molded edge with clear license cover and chrome backing plate. The ball-milled style features chrome-plated billet-aluminum construction with the Star logo and chrome backing plate. Chrome mounting hardware is included with both styles.

Smooth

**STR-4NK26-25-00** \$59.95

Ball Milled with Logo

**STR-4NK27-01-03** \$96.95

## 7. Expandable Custom Cover

This unique and versatile cover incorporates expandable windshield and backrest pockets to accommodate everything from a stock V Star 950 to a fully accessorized Tourer, yet maintains that custom-fit look. The top half uses premium Evolution® IV fabric that is breathable, water repellent and UV-resistant. The bottom half is constructed of duck canvas for heat protection against exhaust pipes. Both materials provide excellent outdoor protection. (Not recommended for trailering.)

**STR-4WMCU-SC-VR** \$134.95

## 8. Dust Cover

Great for protecting your Star in wind-protected places such as a garage. The machine-washable knit polyester fabric will not scratch paint, windshield, or chrome.

**STR-4WMDS-TC-VR** \$75.95



These accessories fit all V Star 950 models unless otherwise noted  
\*Required if installing the accessory Wide Handlebars (5S7-F61B0-U0-00)



**V Star® 1100/ V Star® 650 Accessories**

**Comfort Cruise™ Seats**

Comfort Cruise seats offer exceptional riding comfort. Whether you're going across town or across the country, Star Custom Accessories has a seat that is just right for your riding style.

Features include:

- Traditional styling and quality that you have come to expect from all Star Custom Accessories.
- Luxurious real leather seating panels.
- Hand-laid fiberglass seat pan for consistent fit.
- Soft foam edges for added comfort and protection for painted surfaces.
- Soft foam nose for a close fit to the tank.
- Custom foam formulation for a "soft-to-touch" feel along with firmness and support for an all-day ride.

**1. Stiletto**

- Fits V Star 1100 Custom  
**STR-5EL22-3V-H0** \$321.95
- Fits V Star 1100 Classic  
**STR-5KS22-3V-H0** \$321.95
- Fits V Star 650 Custom  
**STR-4YV22-3V-H0** \$321.95
- Fits V Star 650 Classic  
**STR-5BN22-3V-H0** \$321.95

**2. Studded**

- Fits V Star 650 Custom  
**STR-4YV24-1V-H1** \$321.95

**3. Studded with Skirt and Conchos**

- Fits V Star 1100 Custom  
**STR-5EL24-1V-H4** \$321.95
- Fits V Star 1100 Classic  
**STR-5KS24-1V-H4** \$321.95
- Fits V Star 650 Classic  
**STR-5BN24-1H-04** \$321.95



**4. Boulevard™**

- Fits V Star 1100 Custom  
**STR-5EL24-1V-H7** \$299.95
- Fits V Star 1100 Classic  
**STR-5KS24-1V-H7** \$299.95
- Fits V Star 650 Classic  
**STR-5BN24-1V-H7** \$299.95

**5. Comfort Cruise Pillion Pads**

Comfort Cruise pillion pads offer a new dimension of passenger comfort. Designed to coordinate with Comfort Cruise Solo Seats to give your bike the right look, with a comfortable feel your passenger will appreciate.

**a. Tour**

- Studded
- Fits V Star 1100 Custom  
**STR-5EL25-3V-H2** \$267.95
- Fits V Star 1100 Classic  
**STR-5KS25-3V-H2** \$267.95
- Fits V Star 650 Custom  
**STR-4YV25-3V-H2** \$267.95
- Fits V Star 650 Classic  
**STR-5BN25-3V-02** \$267.95

**b. Long**

- Studded
- Fits V Star 1100 Custom  
**STR-5EL25-2V-H2** \$182.95
- Fits V Star 1100 Classic  
**STR-5KS25-2V-H2** \$182.95
- Fits V Star 650 Custom  
**STR-4YV25-2V-H2** \$182.95
- Fits V Star 650 Classic  
**STR-5BN25-2V-H2** \$182.95





### 6. Custom Backrest Pad

Studded

**STR-4YV41-5V-02** \$81.95

### 7. Passenger Backrest and Pad

Highly polished with brilliant chrome finish, complements both stock and Custom Tour Pillion pads.

Three-piece system, with backrest sidearms, upright and pads sold individually.

#### a. Backrest Sidearms

Fits V Star 1100 Classic

**STR-5KS41-10-00** \$134.95

Fits V Star 1100 Custom

**STR-5EL41-10-00** \$134.95

Fits V Star 650 Classic

**STR-5BN41-10-00** \$134.95

Fits V Star 650 Custom

**STR-4TR41-10-00** \$134.95

#### b. Backrest Upright

Standard (Shown)

**STR-5BN41-30-01** \$96.95

Tall

**STR-5BN41-30-02** \$107.95

#### c. Backrest Pad

Standard

Plain (Shown)

**STR-5BN41-50-01** \$37.95

Studded

**STR-5BN41-50-02** \$43.95

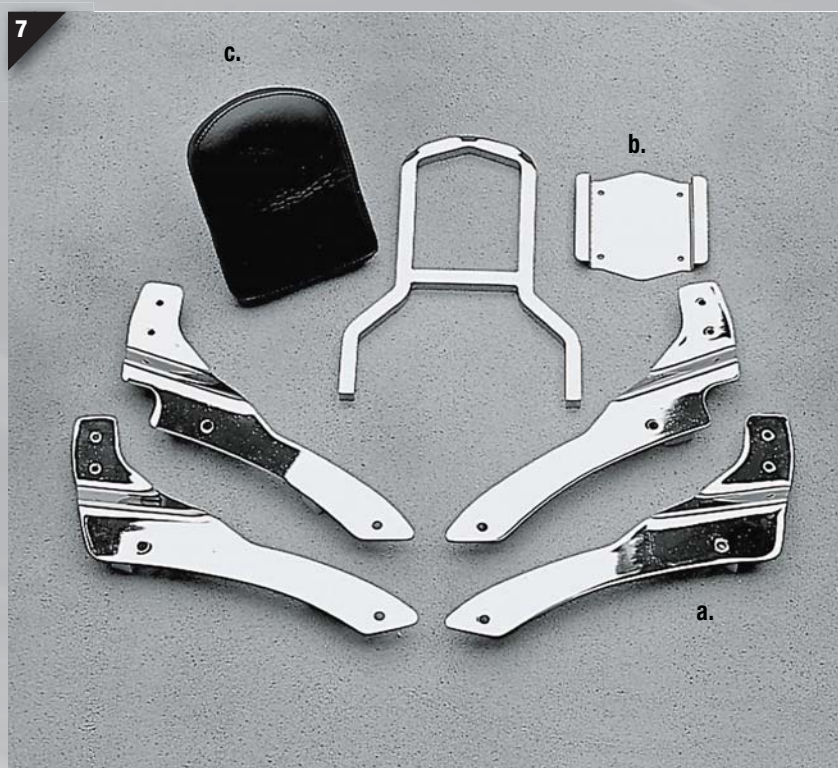

## STAR

V Star® 1100/ V Star® 650 Accessories

### 1. Mini Tank Cover

This soft, leather mini cover simply attaches to the fuel tank. Looks good and helps protect the paint from pant leg wear.

Fits all V Star 1100 models

**STR-5EL49-50-00** \$53.95

Fits all V Star 650 models

**STR-4YV49-50-00** \$53.95

### Leather Tank Panels

Tank Panels are constructed of hand-selected leather, double stitched at stress points. Backed with suede leather to help protect the paint.

### 2. Wide with Pocket

Studded

Fits all V Star 1100 models

**STR-5EL49-30-01** \$96.95

Fits all V Star 650 models

**STR-4YV49-30-01** \$96.95

Plain

Fits all V Star 1100 models

**STR-5EL49-30-00** \$91.95

Fits all V Star 650 models

**STR-4YV49-30-00** \$91.95

### 3. Narrow

Studded

Fits all V Star 1100 models

**STR-5EL49-02-01** \$65.95

Fits all V Star 650 models

**STR-4YV49-02-01** \$67.95

Plain

Fits all V Star 1100 models

**STR-5EL49-02-00** \$64.95

Fits all V Star 650 models

**STR-4YV49-02-00** \$64.95



### 4. Star Concho Backrest Emblem

This rich, gold-plated Star Concho measures 2-3/8" across. Strong adhesive backing for easy, permanent installation. Perfect for the V Star backrest or any flat area.

**STR-5BN26-34-60** \$34.95

### 5. Star Conchos

Use these Star Conchos to personalize your apparel, bags, tank panels, and more. (Sold in pairs.)

**STR-4NK78-10-00** \$22.95

### 6a. Mink Oil

Use to waterproof, preserve and protect your leather accessories.

4-oz. Jar

**ACC-MINKC-RE-AM** \$2.95

### 6b. Saddle Soap

Use to clean, condition and restore your leather accessories.

4-oz. Jar

**ACC-SADDL-ES-AP** \$2.95

### 6c. Black Leather Polish

Use to restore black leather to its natural luster by putting color back into the leather.

1.5-oz. Jar

**ACC-CREAM-PL-SH** \$2.49



### 7. V Star Hard Saddlebags

These injected-molded, high-impact ABS saddlebags are designed to complement the smooth lines of the V Star Classics. With over 2600 cubic inches of combined storage they are more than just good lookers. The saddlebags also come unpainted so you can add a personal touch with your own custom paint. Installation requires either existing Silverado saddlebag mounts or accessory Silverado mounting hardware (sold separately). (13-1/2" H x 23" L x 11-1/4" W)

Fits V Star 1100 Classic and V Star 650 Classic

Primer (All models)

**STR-5KS72-00-00** \$929.95

Candy Red ('09~'10 models)

**STR-5KS72-00-CR** \$1,029.95

Galaxy Blue ('09 model)

**STR-5KS72-00-GB** \$1,029.95

Charcoal Silver ('05 model)

**STR-5KS72-00-CH** \$1,029.95

Liquid Gold ('05 model)

**STR-5KS72-00-LG** \$1,029.95

Ice Blue ('04 model)

**STR-5KS72-00-IB** \$1,029.95

Liquid Silver ('04~'07 models)

**STR-5KS72-00-LS** \$1,029.95

Pearl White ('04~'07 models)

**STR-5KS72-00-NW** \$1,029.95

Raspberry Metallic ('04 model)

**STR-5KS72-00-RM** \$1,029.95

Raven ('04~'10 models)

**STR-5KS72-00-RA** \$1,029.95

Beach Sand ('03 model)

**STR-5KS72-00-BS** \$1,029.95

Cerulean Silver ('03 and '07 models)

**STR-5KS72-00-CS** \$1,029.95

Indigo ('03 model)

**STR-5KS72-00-IN** \$1,029.95

Onyx ('03 model)

**STR-5KS72-00-YB** \$1,029.95

Pearl White ('03 model)

**STR-5KS72-00-PW** \$1,029.95

Root Beer ('03 model)

**STR-5KS72-00-RB** \$1,029.95

Taupe ('03 model)

**STR-5KS72-00-TP** \$1,029.95

### Replacement Latch Set

(Not shown)

Individual replacement latch sets are now available should the latches break on your V Star Hard Saddlebags.

**USA-4WM72-12-00** \$37.95



8



### 8. Hard Saddlebag Liners

Constructed of heavy-duty ballistic nylon for added durability, these saddlebag liners provide carry-away convenience for your luggage. Also features an embroidered Star logo for a quality look and feel. (Sold in pairs.)

**STR-4WM72-90-00** \$86.95

### 9. Silverado Saddlebags

The distinctive design uses hand-crafted quality leather with an internal frame to hold the bag's shape when empty. The studded bags are the same as those used on the Silverado model. Plain-style bags feature an embossed Star logo and coordinate with either the stock or the plain custom seats. Saddlebag Mounting Hardware sold separately. (11" H x 21" L x 7-1/2" W)

Plain

**STR-5VN73-00-00** \$787.95

Studded

**STR-5VN73-02-00** \$787.95



9

### Saddlebag Mounting Hardware

(Not shown)

Mounts V Star Hard Saddlebags and Silverado Saddlebags.

Fits V Star 1100 Classic

**STR-5KS73-40-10** \$174.95

Fits V Star 650 Classic

**STR-5BN73-40-10** \$150.95

**Throw-Over Saddlebags**

These handcrafted, throw-over design leather bags feature a plastic base insert and a hard rubber back to help hold their shape when empty. Interior pockets and zippered pouch included. Saddlebag Support Bars required for installation.

**1. Star Slant Saddlebags**

(10" x 15-1/2" x 5")

Plain

**STR-4NK73-10-00** \$369.95

Fringed

**STR-4NK73-10-01** \$407.95

Studded

**STR-4NK73-10-02** \$417.95

**2. Classic Deluxe Saddlebags**

(10" x 15-1/2" x 5")

Plain

**ABA-3JK73-00-02** \$343.95

Fringed

**ABA-3JK73-00-00** \$374.95

Studded

**ABA-3JK73-00-01** \$407.95

**3. Classic Saddlebags**

(10" x 12" x 4-1/2")

Plain

**ABA-3JK73-00-04** \$296.95

Fringed

**ABA-3JK73-00-05** \$343.95

Studded

**ABA-3JK73-00-03** \$343.95

**4. Slant Saddlebags**

(10" x 12" x 4-1/2")

Plain

**ABA-3JK73-00-06** \$321.95

Fringed

**ABA-3JK73-00-07** \$353.95

Studded

**ABA-3JK73-00-08** \$386.95



**5. Cruiselite® Classic Saddlebags**

These handcrafted, throw-over design bags of a premium synthetic material feature a metal frame, plastic base insert and a hard rubber back to help hold the bags shape when empty. Saddlebag Support Bars required for installation. (10" x 12" x 4-1/2")

Plain

**STR-5KS73-50-00** \$229.95

Studded

**STR-5KS73-50-02** \$269.95





### 6. Classic Tour Trunks

Classic, rugged design handcrafted using high-quality leather. Features an internal frame to hold its shape even when empty. The main compartment is 12" x 13" x 7" with three handy external storage compartments. Requires rear luggage rack.

Studded  
**STR-4NK49-23-00** \$460.95

### 7. Expandable Tank Bag

Made of tough, water-resistant ballistics nylon. Provides 550 cubic inches of convenient storage for small items for short day trips and quickly expands to over 900 cubic inches when you need the extra room. Features include an embroidered Star logo, five interior pockets and reversible waterproof map pocket. For carry-away convenience, bag attaches to tank with special, high-strength magnets that are shielded to help protect electronic devices you may be carrying. (11" L x 13" W x 4" H or 7-1/2" expanded)

**STR-4WM64-21-00** \$96.95



### 8. Leather Tail Bag

This high-quality, all-leather bag is designed to attach quickly to our accessory rear fender rack to add over 300 cubic inches of storage. Includes a small zippered pouch on top. Built-in strap allows for easy carry away. Foam integrated into the side panels helps the bag keep its shape even when empty. Coordinates with other Star leather products. (11" x 8" x 3")

Studded  
**STR-4WM63-10-01** \$214.95  
(Plain style shown not available)

### 9. Leather Tool Bags

Handcrafted leather bags with Star Concho provide both function and style. Dual mounting straps, with double stitching at stress points. (10" x 5" x 3")

Plain  
**STR-4NK46-11-00** \$53.95  
Fringed  
**STR-4NK46-12-00** \$65.95  
Studded  
**STR-4NK46-13-00** \$65.95

### 10. Leather Windshield Bags

These convenient bags are constructed of premium supple leather and include special mount brackets designed to fit all V Star windshields. Twist closure makes access quick and easy.

Plain  
**STR-4NK46-21-00** \$65.95  
Studded  
**STR-4NK46-23-00** \$65.95

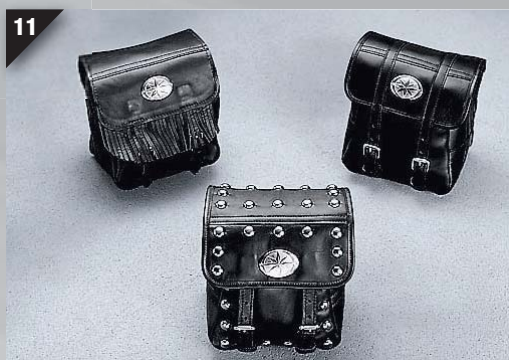

### 11. Leather Backrest Bags

Handcrafted leather bags with Star Concho provide both function and style. Dual mounting straps, with double stitching at stress points.

Plain  
**STR-4NK47-11-00** \$75.95  
Fringed  
**STR-4NK47-12-00** \$79.95  
Studded  
**STR-4NK47-13-00** \$88.95

## STAR

V Star® 1100/ V Star® 650 Accessories

### 1. Billet Mirrors

Designed to fit a more aggressive personality, while maintaining excellent visibility. Available in two head shapes and three finishes to coordinate with accessory and original equipment components. Smooth and brushed styles have holes in the stem. Left and right hand mirrors sold separately.

#### Oval

Smooth, Left	
<b>STR-5PX13-41-00</b>	\$129.95
Smooth, Right	
<b>STR-5PX13-42-00</b>	\$129.95
Ball Milled, Left	
<b>STR-5PX13-31-00</b>	\$129.95
Ball Milled, Right	
<b>STR-5PX13-32-00</b>	\$129.95
Brushed, Left	
<b>STR-5PX13-61-00</b>	\$129.95
Brushed, Right	
<b>STR-5PX13-62-00</b>	\$129.95

#### Tear Drop

Ball Milled, Left	
<b>STR-5PX13-11-00</b>	\$129.95
Ball Milled, Right	
<b>STR-5PX13-12-00</b>	\$129.95
Brushed, Left	
<b>STR-5PX13-51-00</b>	\$129.95
Brushed, Right	
<b>STR-5PX13-52-00</b>	\$129.95

### 2. Billet Mirrors

Each mirror and stem is highly polished and specially treated before chrome plating for an extra-durable finish. Left and right mirrors sold separately.

#### Oval

Smooth, Left	
<b>STR-4NK13-41-00</b>	\$118.95
Smooth, Right	
<b>STR-4NK13-42-00</b>	\$118.95
Ball Milled, Left	
<b>STR-4NK13-31-00</b>	\$118.95
Ball Milled, Right	
<b>STR-4NK13-32-00</b>	\$118.95

#### Tear Drop

Smooth, Left	
<b>STR-4NK13-21-00</b>	\$118.95
Smooth, Right	
<b>STR-4NK13-22-00</b>	\$118.95
Ball Milled, Left	
<b>STR-4NK13-11-00</b>	\$118.95
(Ball Milled Right not available)	

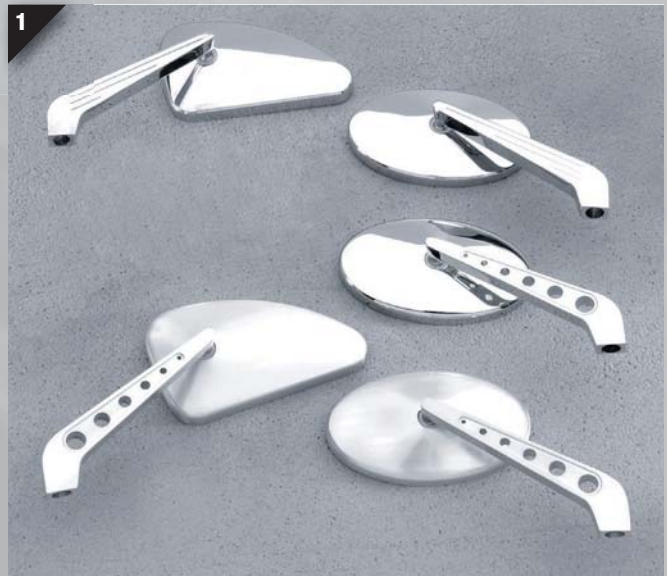

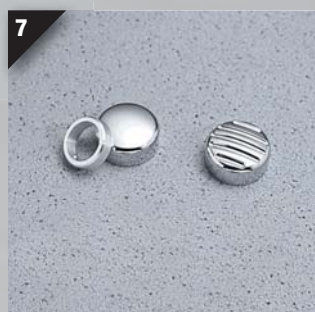
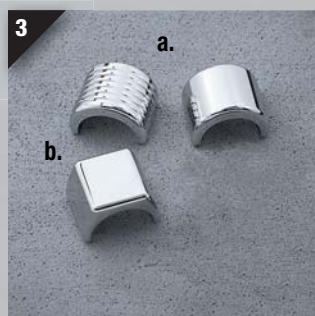

### 3. Billet Front Axle Bolt Covers

Precisely machined then highly polished and specially treated for the most durable chrome finish. Metric Allen mounting screws included.

a. Round  
Smooth

**STR-4WM27-04-01** \$96.95

Ball Milled  
**STR-4WM27-04-02** \$96.95

b. Square  
Smooth

**STR-4NK27-04-01** \$95.95

#### 4a. Billet Fork Cap Covers

Smooth  
**STR-4YV27-02-01** \$45.95

Ball Milled  
**STR-4YV27-02-02** \$45.95

#### 4b. Billet Fork Stem Nut Cap

Smooth  
**STR-4YV27-06-01** \$26.95

Ball Milled  
**STR-4YV27-06-02** \$26.95

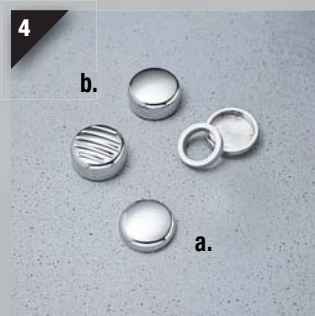

### 5. Billet Rear Axle Bolt Covers

Fits all V Star 650 models  
Smooth

**STR-4YV27-05-01** \$51.95  
(Ball milled not available)

### 6. Billet Front Brake Caliper Accents

These highly-polished, triple-plated billet covers are adhesive-backed for quick and easy installation. Available in smooth or ball-milled finish. (Set of two.)

Fits all V Star 1100 models  
Smooth

**STR-5KS27-16-01** \$39.95

Ball Milled  
**STR-5KS27-16-02** \$41.95

### 7. Billet Differential Filler Bolt Cover

Smooth  
**STR-4YV27-08-01** \$25.95

Ball Milled  
**STR-4YV27-08-02** \$27.95



### 8. Billet Banjo Joint Cover

Two-piece set to cover the bolt head on the front brake's reservoir and caliper banjo joints on the V Star 650 Classic and Custom models or both front-brake caliper banjo-joint bolts on the V Star 1100 Classic and Custom models.

**STR-4YV27-23-01** \$27.95

### 9. Billet Caliper Bleeder Covers

Use to enhance the brake caliper bleeder for a detailed look.

Fits all V Star 1100 models  
Three-Piece Set

**STR-4WM27-29-01** \$35.95

Fits all V Star 650 models  
One-Piece cover

**STR-4YV27-29-01** \$12.95

### 10. Billet Rear Brake Light Switch Cover

Installs easily over the stock brake light switch.

**STR-4YV27-39-01** \$27.95

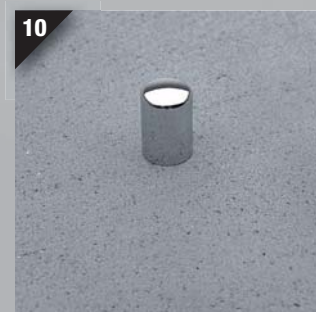



**1. Speedstar® Air Cleaner Assembly**

Replace the stock air cleaner with this race-inspired Speedstar air cleaner. All hardware included for easy installation.

Fits all V Star 1100 Classic and Custom models

Chrome (Shown)  
**STR-5KS09-57-01** \$182.95

Raven  
**STR-5KS09-57-RA** \$193.95

Replacement Filter Element  
**5PX-14461-00-00** \$15.97

**2. Billet Air Cleaner Insert**

Ball-milled design with polished chrome finish. Adhesive backed for easy installation over the stock air cleaner cover.

Fits all V Star 1100 models

**STR-5KS27-42-02** \$43.95

Fits all V Star 650 models

**STR-4YV27-42-02** \$33.95

**3. Billet Oil Filter Access Cover**

Precision-machined, ball-milled design with a highly-polished chrome-plated finish. Chrome hardware included for easy installation.

Fits all V Star 1100 models

**STR-5KS27-43-02** \$43.95

Fits all V Star 650 models

**STR-4YV27-43-02** \$43.95

**4. Billet Speedometer Cable Guide**

Replaces stock cable guide. Hardware included.

Fits V Star 650 Classic

**STR-5BN27-64-01** \$36.95

Fits V Star 650 Custom

**STR-4YV27-64-02** \$36.95

**5. Billet Rear Swingarm Covers**

Machined, polished, and brilliantly chrome-plated covers make the perfect accent for the rear axle of the swingarm. All hardware included for easy installation. (Sold in pairs.)

Fits all V Star 650 models

Smooth  
**STR-5BN27-53-01** \$134.95

Ball Milled  
**STR-5BN27-53-02** \$134.95

**6. Billet Choke Knob Cover**

Installs in less than a minute with a unique screw-on design.

Fits V Star 650 Classic or Custom

**STR-4NK27-21-01** \$43.95

**7. Billet Wire Harness Guides**

Replace the nylon cable-ties with these chrome guides. (Sold in pairs.)

**STR-4NK27-62-01** \$70.95

**8. Billet Oil Filler Cap**

Simply replace the stock cap with this brilliant triple-chrome-plated filler cap. Includes O-ring.

**STR-5BN27-14-01** \$41.95





### 9. Billet Rider Floorboard Covers

These floorboard covers have a molded rubber cushion and ribs for a fresh look and added durability. Highly-polished with a rich chrome finish to coordinate with other Star accessories. (Sold in pairs.)

Fits V Star 1100 Classic  
**STR-4WM27-11-13** \$279.95

Replacement Rubber, Left  
**STR-4WM27-11-21** \$28.95  
 Replacement Rubber, Right  
**STR-4WM27-11-22** \$28.95

### 10. Chrome Rider Floorboards

Beautifully chrome-plated floorboards with durable rubber pad replace your stock foot pegs for classic cruiser appearance and comfort. Detailed with Star logo.

Fits V Star 1100 Custom  
**STR-5EL57-10-00** \$199.95  
 Fits '98-'01 V Star 650 Classic and '98-'09 V Star 650 Custom  
**STR-5BN57-10-00** \$172.95

Replacement Rubber Pads  
**STR-5BN57-1E-Q2** \$28.95



### 11. Billet Brake Pedal Cover

Highly-polished and specially treated for a durable and rich chrome finish. Includes rubber inserts for a look that coordinates with other chrome accessories.

Fits V Star 1100 Classic  
**STR-4NK27-12-03** \$48.95

Replacement Rubber (includes glue)  
**STR-4NK27-12-98** \$9.95

### 12. Chrome Passenger Foot Pegs with Rubber Inserts

Chrome-plated foot pegs designed to replace stock passenger pegs. All hardware included for easy installation and proper fit.

**STR-5BN36-20-03** \$65.95

### 13. Billet Passenger Floorboards

These passenger floorboards incorporate a molded rubber cushion and ribs for a fresh look and added durability. Highly-polished with a rich chrome finish to coordinate with other Star accessories. Requires passenger floorboard mounts (STR-5KS57-40-00) sold separately.

**STR-4WM57-30-01** \$230.95

Replacement Rubber  
 (Order two if replacing rubber on both boards.)  
**STR-4WM57-30-21** \$25.95

### 14. Passenger Floorboards

Cast aluminum floorboards with rubber inserts designed to coordinate with the stock rider floorboards. Requires passenger floorboard mounts (STR-5KS57-40-00) for installation. (Sold in pairs.)

**STR-4YE57-20-02** \$150.95

Replacement Rubber  
 (Order two if replacing rubber on both boards.)  
**4YE-27433-00-00** \$11.95

Passenger Floorboard Mounts  
 (Not shown)  
**STR-5KS57-40-00** \$65.95

#### 1. Solo Seat Rail

Styled to complement both stock and Star custom seats, this uniquely designed seat rail is polished and chrome-plated to a show-worthy appearance. Rail is for solo seat application only; not compatible with passenger seats.

Fits V Star 1100 Classic

**STR-5KS24-60-01** \$160.95

Fits V Star 650 Classic (Shown)

**STR-5BN24-60-01** \$160.95



#### 5. Front Fender Trim Rail

Classic styling and a brilliant chrome finish enhance the front fender.

Fits V Star 1100 Classic and V Star 650 Classic

**STR-5BN14-10-00** \$80.95

#### 2. Big Bar Engine Guards

The ultimate in classic cruiser styling. The big 1-1/4-inch tubing matches the V Star 1100's classic personality. (Not compatible with Lower Deflectors.)

Fits V Star 1100 Classic

**STR-5KS31-20-00** \$214.95



#### 6. Rear Fender Rack

Unique styling complements the rear fender while protecting the paint and providing a tie-down point for luggage. For use with solo seat only; not compatible with passenger seats.

Fits V Star 1100 Classic

**STR-5KS51-20-00** \$107.95

Fits V Star 1100 Custom

**STR-5EL51-20-00** \$107.95

Fits V Star 650 Classic

**STR-5BN51-20-00** \$107.95

#### ⚠ WARNING

These engine guards may provide limited protection against cosmetic vehicle damage in certain situations, such as if the motorcycle tips over while stopped or moving slowly. These engine guards are not manufactured or intended to protect the rider from injury in a collision.



#### 7. Luggage Rack

A simple design with upswept tail provides function with a brilliant chrome-plated finish for personalization.

Fits V Star 1100 Classic

**STR-5KS51-10-00** \$129.95

Fits V Star 650 Classic

**STR-5BN51-10-01** \$129.95

#### 3. Engine Guards

Sturdy design, triple-chrome-plated finish, and easy-to-install. 1" tubing. (Sold in pairs.)

Fits all V Star 1100 models (shown)

**STR-5EL31-00-00** \$129.95

Fits all V Star 650 models

**STR-5BN31-00-00** \$129.95



#### 8. Rear Rack

Chrome-plated steel tubing rack accents rear fender.

Fits V Star 650 Custom

**STR-4TR51-10-00** \$86.95

#### 4. Saddlebag Support Bars

Designed to help keep saddlebags off the fender and allow clearance for swing arm movement. (Sold in pairs.)

Fits V Star 1100 Classic

**STR-5KS73-40-00** \$84.95

Fits V Star 1100 Custom

**STR-5EL73-40-00** \$84.95

Fits V Star 650 Classic

**STR-5BN73-40-00** \$84.95

Fits V Star 650 Custom

**STR-4TR73-40-00** \$84.95



## 9. Rear Luggage Rack

Coordinates with passenger backrest styling. Backrest required for installation.

Fits all V Star model backrests  
**STR-5EL51-10-00** \$123.95



## 10. Chrome Master Cylinder Cover

Attaches to master cylinder reservoir for a smooth, highly-polished, chrome-plated look.

**STR-5BN18-10-01** \$18.95



## 11. Chrome Frame Inserts

High-strength adhesive backing makes this four-piece chrome accent set a quick and easy way to customize your bike.

**STR-5BN26-06-00** \$39.95

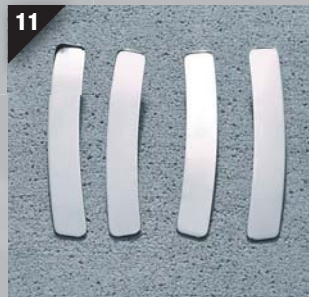

## 12. Chrome Battery Side Covers

Replace the stock painted side covers with these chrome-plated covers for a custom accent. Injected molded ABS. (Sold in pairs.)

Fits V Star 1100 Classic  
**STR-5KS26-30-00** \$77.95  
 Fits all V Star 650 models (Shown)  
**STR-5BN26-30-00** \$77.95



## 13. Chrome Rear Brake Reservoir Cover

Polished and chrome-plated cover simply replaces stock cover for a detailed look.

Fits all V Star 1100 models  
**STR-4NK26-13-00** \$34.95



## 14. Chrome Rear Fender Stays

These factory rear fender stays are beautifully polished and chrome-plated. Kit includes right and left fender stays and chrome hardware for easy installation.

Fits '98 V Star 650 Classic  
**STR-5BN81-10-00** \$178.95

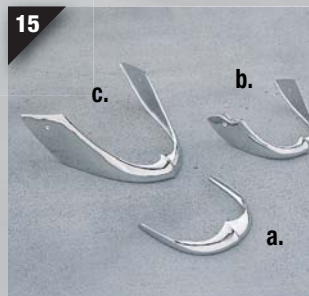

## 15. Chrome Metal Fender Tips

These cast metal fender tips are carefully polished and brilliantly chrome-plated to provide a classic look. (Installation requires drilling of fenders.)

- a. Front of Front Fender**  
 Fits V Star 1100 Classic  
**STR-5KS26-90-00** \$59.95  
 Fits V Star 650 Classic  
**STR-5BN26-90-00** \$61.95
- b. Rear of Front Fender**  
 Fits V Star 1100 Classic  
**STR-5KS26-91-00** \$70.95  
 Fits V Star 650 Classic  
**STR-5BN26-91-00** \$70.95
- c. Rear Fender**  
 Fits V Star 1100 Classic  
**STR-5KS26-92-00** \$86.95  
 Fits V Star 650 Classic  
**STR-5BN26-92-00** \$77.95

## 16. Chrome Allen Bolt Plugs

Nickel-chrome-plated plugs are available in three sizes to fit most of the Allen bolts found on Star models.

- 5mm (Box of 20)  
**STR-4NK26-01-20** \$12.95
- 6mm (Box of 10)  
**STR-4NK26-02-10** \$7.95
- 8mm (Box of 10)  
**STR-4NK26-03-10** \$7.95



### 1. Road Star Handlebars

The Road Star style handlebar features wider and lower positioning (3-5/8" rise, 12" pullback, 33-5/8" width).

**STR-4WM75-13-00** \$75.95

### 2. Double "T" Bars

Drag bike styling (8" rise, 6" pullback, 27-1/4" width).

Fits V Star 1100 Classic, V Star 1100 Custom and V Star 650 Custom

**STR-5KS75-12-01** \$119.95

### 3. Billet Handlebar Risers

CNC-machined risers and upper clamp provide 2-1/4" rise and 1-1/4" pullback over the stock risers. (Sold in pairs.)

Smooth

**STR-5PX75-70-01** \$193.95

Brushed

**STR-5PX75-70-07** \$203.95

**NOTE: Depending on the positioning of handlebars and related components, custom extended-length cables and hoses may be required.**

### 4. Billet Handlebar Risers and Flat Bar

Designed for the custom drag-bike look, these billet risers and flat bar replace the stock bars and risers. Available in smooth and brushed finishes to coordinate with other accessories (when used as a set, bars have 6-12" rise, 10-1/2" pullback, 34-1/4" width).

a. Handlebar Risers

Smooth

**STR-5PX75-50-08** \$214.95

b. Flat Bar

**STR-5PX75-14-00** \$69.95

### 5. Chrome Upper Handlebar Clamps

These stock upper clamps have been highly polished and brilliantly chrome-plated to a show quality finish.

Fits '98~'09 V Star 650/ 1100 Custom, '99~'04 V Star 650/ 1100 Classic

**STR-5BN75-41-00** \$57.95

### 6. Billet Handlebar Clamp

Precision-machined, ball-milled design with Star logo, highly-polished and specially treated for a durable chrome finish.

Fits '98~'07 V Star 1100/ 650 Custom and '98~'04 V Star 1100/ 650 Classic

**STR-4YV27-17-03** \$67.95

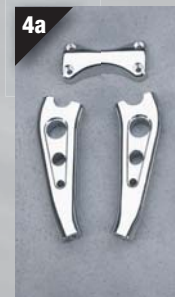

## 7. Chrome Grips

These custom grips include rubber ribs for styling and grip. Attractively priced and easy-to-install. (Sold in pairs.)

**STR-4NK37-10-11** \$59.95

## 8. Braided Stainless Steel Cables

Upgrade the appearance of your Star cruiser by replacing the stock black cables with these braided stainless steel cables built to exacting stock specifications. Nylon inner liner for smooth operation. Cable has a rugged clear coat on its full length to make it easier to clean, while helping to protect windshields and painted surfaces. (Dealer installation recommended.)

### Throttle Cable Set

Fits V Star 1100 Classic  
**STR-5KS48-10-SD** \$86.95

Fits V Star 1100 Custom  
**STR-5EL48-10-SD** \$86.95

Fits V Star 650 Classic  
**STR-5BN48-10-SD** \$86.95

Fits V Star 650 Custom  
**STR-5FB48-10-SD** \$86.95

### Clutch Cable

Fits V Star 1100 Classic  
**STR-5KS48-20-SD** \$49.95

Fits V Star 1100 Custom  
**STR-5EL48-20-SD** \$49.95

Fits V Star 650 Classic  
**STR-5BN48-20-SD** \$49.95

Fits V Star 650 Custom  
**STR-5FB48-20-SD** \$49.95

## 9. Braided Stainless Steel Brake Lines

All of our hydraulic lines are constructed using braided 308 stainless steel brake hose with a Teflon® inner liner. Brake line has a rugged clear coat on its full length to make it easier to clean, while helping to protect windshields and painted surfaces. (Dealer installation recommended.)

### Front Lower

Fits V Star 1100 Classic  
**STR-5KS48-40-SD** \$96.95

Fits '01~'06 V Star 1100 Custom  
**STR-5EL48-40-SD** \$96.95

### Front Upper

Fits V Star 1100 Classic  
**STR-5KS48-30-SD** \$59.95

Fits '01~'06 V Star 1100 Custom  
**STR-5EL48-30-SD** \$59.95

### Front

Fits V Star 650 Classic  
**STR-5BN48-30-SD** \$65.95

Fits V Star 650 Custom  
**STR-5FB48-30-SD** \$65.95

### Rear

Fits all V Star 1100 models  
**STR-5KS48-50-SD** \$75.95



### Star Custom Accessory Windshields

Our tough polycarbonate windshields not only offer the superior fit and finish you would expect, we went a step further by treating them with the new-generation Quantum™ Coating to provide a long lasting, durable, protective finish. This makes the windscreen three times more scratch-resistant than typical acrylic products, and also much more resistant to damage from bugs, stone chips, road grime, or even everyday cleaning. This extra attention to detail will help keep your windshield looking new longer, and that's a clear benefit you'll enjoy on every ride.

#### 1. V Star Windshields

Solar-bronze-tinted windshield features traditional styling and a 2" height adjustment. Sized to provide upper body wind protection. Available in Tall (21-1/4") and Low (16-1/4") heights\*\*. Replacement windshields are available in both low and tall heights. V Star 650 styles sold with mounts. V Star 1100 windshields and mounts sold separately.

Fits V Star 1100 Classic

Low Assembly

**STR-5KS06-10-00** \$219.95

Tall Assembly

**STR-5KS03-10-00** \$259.95

Windshield Mounting Hardware

**STR-5KS03-40-02** \$107.95

Low Replacement Windshield

**STR-5BN06-11-00** \$129.95

Tall Replacement Windshield

**STR-5BN03-11-00** \$159.95

Fits V Star 1100 Custom

Low Assembly

**STR-5EL06-10-00** \$219.95

Tall Assembly

**STR-5EL03-10-00** \$259.95

Windshield Mounting Hardware

**STR-5EL03-40-00** \$107.95

Low Replacement Windshield

**STR-5EL06-11-00** \$129.95

Tall Replacement Windshield

**STR-5EL03-11-00** \$159.95

Fits V Star 650 Classic

Low Assembly with Mounts

**STR-5BN06-00-00** \$319.95

Tall Assembly with Mounts

**STR-5BN03-10-00** \$341.95

Low Replacement Windshield

**STR-5BN06-11-00** \$129.95

Tall Replacement Windshield

**STR-5BN03-11-00** \$159.95

Fits V Star 650 Custom

Low Assembly with Mounts

**STR-4TR06-00-00** \$279.95

Tall Assembly with Mounts

**STR-4TR03-10-00** \$319.95

Low Replacement Windshield

**STR-4TR06-11-00** \$129.95

Tall Replacement Windshield

**STR-4TR03-11-00** \$153.95

#### 2. Silverado® Windshields

This is the same windshield used on the V Star Silverado® models. Available in Tall (21-1/4") or Short (16-1/4") heights\*\*. Mounting hardware required, sold separately. Fits V Star 1100 Classic and V Star 650 Classic

Tall (21-1/4"\*\*)

**STR-5KS03-10-01** \$361.95

Short (16-1/4"\*\*)

**STR-5KS06-10-01** \$361.95

Mounting hardware

**STR-5KS03-40-02** \$107.95

#### 3. Boulevard™ Windshield

Solar bronze-tinted windshield (11" high\*\*) provides unique styling, and deflects wind from your chest area. Includes triple-plated mounting hardware.

**STR-5KS05-00-30** \$166.95

#### 4. Chrome Lower Deflectors

Classic styling and function. Deflectors attach to windshield mounts. Requires installation of V Star windshield or V Star windshield mounts. (Sold in pairs.) Not compatible with the Big Bar Engine Guards.

Fits V Star 1100 Classic and V Star 650 Classic

**STR-5BN08-50-00** \$101.95

Fits V Star 1100 Custom and V Star 650 Custom

**STR-4YV08-50-00** \$96.95



5



### 5. Passing Lamps

The classic look. Lamp kit includes traditional-styled lamps with on/ off switch and wire harness. Available in either sealed-beam or halogen (H3) lamps. Hardware kits will mount either with or without windshield. Order lamps and mounting hardware separately. (Dealer installation recommended.)

#### Passing Lamps

Sealed Beam

**STR-4NK35-10-00** \$118.95

Halogen

**STR-4NK35-10-01** \$118.95

#### Passing Lamp Mounts

Fits V Star 1100 Classic and V Star 650 Classic

**STR-5KS35-40-00** \$107.95

Fits V Star 1100 Custom and V Star 650 Custom

**STR-4YV35-40-00** \$107.95

#### Replacement Light Bulb

Sealed Beam

**STR-4NK35-50-00** \$18.95

Halogen (H3)

**STR-4NK35-50-01** \$18.95

Replacement Lens (H3)

**STR-4NK35-17-01** \$22.95

#### Replacement Toggle Switch

Sealed Beam

**STR-4NK35-51-00** \$16.95

Halogen (H3)

**STR-4NK35-51-01** \$17.95

### 6. Custom Tri-Bar Headlight

Give your bike a truly custom look by simply replacing your stock headlight with this halogen tri-bar style.

Fits V Star 1100 Classic and V Star 650 Classic

**STR-4WM45-10-00** \$106.95



6



7



### 7. Custom Tri-Bar Passing Lamps

Designed to coordinate with the Tri-Bar Headlight to complete the custom lighting package. Passing lamp mounts required for installation (sold separately).

**STR-4WM35-10-EA** \$129.95

Replacement Glass Housing

**STR-4WM35-50-EA** \$32.95

STAR  
V Star® 1100/ V Star® 650 Accessories

These accessories fit all V Star 100/V Star 650 models unless otherwise noted.

\*\*Height measured from top of headlight cutout to top of windshield.



## STAR

V Star® 1100/ V Star® 650 Accessories

### 1. Visors

Triple-chrome-plated visors include a subtle Star logo.

#### Headlight Visors

Fits V Star 1100 Classic and V Star 650 Classic

**STR-4NK58-10-00** \$19.95

Fits '98~'00 V Star 1100 Custom and V Star 650 Custom

**STR-4YV58-10-00** \$16.95

#### Passing Lamp Visors

**STR-4NK58-20-00** \$18.95

#### Turn Signal Visors

**STR-4NK58-30-00** \$17.95



### 2. Chrome Instrument Visor

Cast metal visor is polished, and then chrome-plated to a brilliant finish for a classy look. Adhesive tape included for easy installation.

Fits all V Star 1100 models

**STR-5KS04-00-00** \$55.95

Fits all V Star 650 models

**STR-5BN04-00-00** \$55.95



### 3. Billet License Plate Frame

Compact billet license frame kit includes all hardware and backing plate.

Smooth

**STR-5PX27-01-01** \$81.95

Brushed

**STR-5PX27-01-07** \$83.95



### 4. Custom License Frames

License frames are available in two styles. The smooth style features a 1/2" round molded edge with clear license cover and chrome backing plate. The ball-milled style features chrome-plated billet aluminum construction with the Star logo and chrome backing plate. Chrome mounting hardware is included with both styles.

Smooth

**STR-4NK26-25-00** \$59.95

Ball Milled with Logo

**STR-4NK27-01-03** \$96.95

**5. Chrome Taillight Cover**

Detail the taillight for a custom look. Adhesive backed for quick and easy installation.

Fits V Star 1100 Classic and V Star 650 Classic

**STR-4NK58-40-00**      \$35.95

**6. Star Front Fender Ornament**

This rich looking, highly-polished, triple-plated, solid-steel ornament proudly displays the Star logo.

**STR-4NK14-01-00**      \$99.95

**7. Custom Fiberglass Fenders**

These are the same components used on many V Star customs featured in our Custom Series calendars. All components are hand-laid gel coat fiberglass with hole locations pre-marked (some drilling is required for installation). Uses all stock components. (Professional installation and painting are recommended.)

Fits V Star 650 Classic models

Extended Front Fender

**STR-5BN19-11-XX**      \$172.95

Extended Rear Fender

**STR-5BN19-21-XX**      \$214.95

**8. V Star Cover**

Versatile cover made of urethane-coated, weather-resistant polyester to help protect your investment from the elements. Cover includes a canvas heat shield and handy storage bag. Fits all V Star models, even with accessories.

**STR-VSCUS-CV-R1**      \$86.95

**9. Dust Cover**

Great for protecting your Star in wind protected places such as a garage. One size fits all Road Stars and V Stars including a fully dressed Tour Classic to the standard model. The machine washable knit polyester fabric will not scratch paint, windshield, or chrome.

**STR-4WMDS-TC-VR**      \$75.95

## V Star® 250 Accessories

### 1. Custom Sport Shield

Adjustable height helps provide upper body wind protection for riding comfort. Solar-bronze-tinted acrylic plastic construction. (Chrome-plated mounting hardware sold separately.)

**ABA-2GV05-00-30** \$53.95

Mounting hardware  
**ABA-2GV05-40-00** \$127.95

### 2. Classic V Windshield

This classic looking windshield provides upper body wind protection for greater comfort on cross-town and cross-country trips. Height is adjustable. (Chrome-plated mounting hardware sold separately.)

**ABA-1TE06-00-00** \$153.95

Mounting Hardware  
**ABA-2GV06-40-00** \$48.95

### 3. Custom License Frames

These custom frames are available in two finishes. Smooth style features a ½" round molded edge with a clear license cover and chrome backing plate. Ball milled style features chrome-plated billet aluminum construction with Star logo and chrome backing plate. Chrome mounting hardware is included with both styles.

Smooth  
**STR-4NK26-25-00** \$59.95

Ball Milled  
**STR-4NK27-01-03** \$96.95

### 4. Billet License Plate Frame

Compact billet license frame kit includes all hardware and backing plate.

Smooth  
**STR-5PX27-01-01** \$81.95

Brushed  
**STR-5PX27-01-07** \$83.95

### 5. Leather Clutch and Brake Lever Covers

These leather covers are cut from the finest top-grain leather. Sturdy, high-quality laces make attachment quick and easy.

**ABA-3JK37-31-01** \$17.95



## 6. Star Slant Saddlebags

(10" x 15-1/2" x 5")

Plain

**STR-4NK73-10-00** \$369.95

Fringed

**STR-4NK73-10-01** \$407.95

Studded

**STR-4NK73-10-02** \$417.95



## 7. Classic Deluxe Saddlebags

(10" x 15-1/2" x 5")

Plain

**ABA-3JK73-00-02** \$343.95

Fringed

**ABA-3JK73-00-00** \$374.95

Studded

**ABA-3JK73-00-01** \$407.95



## 8. Classic Saddlebags

(10" x 12" x 4-1/2")

Plain

**ABA-3JK73-00-04** \$296.95

Fringed

**ABA-3JK73-00-05** \$343.95

Studded

**ABA-3JK73-00-03** \$343.95



## 9. Slant Saddlebags

(10" x 12" x 4-1/2")

Plain

**ABA-3JK73-00-06** \$321.95

Fringed

**ABA-3JK73-00-07** \$353.95

Studded

**ABA-3JK73-00-08** \$386.95

## 10. Cruiselite® Classic Saddlebags

These handcrafted, throw-over design bags of a premium synthetic material feature a metal frame, plastic base insert and a hard rubber back to help hold the bags shape when empty. Saddlebag Support Bars required for installation. (10" x 12" x 4-1/2")

Plain

**STR-5KS73-50-00** \$259.95

Studded

**STR-5KS73-50-02** \$269.95

## 11. Leather Windshield Bags

These convenient bags are constructed of premium supple leather and include special mount brackets designed to fit all V Star windshields. Twist closure makes access quick and easy.

Plain

**STR-4NK46-21-00** \$65.95

Studded

**STR-4NK46-23-00** \$65.95

## 12. Yamaha Expandable Tank Bag

Durable long-lasting Tri-Max® polyester treated with UVEX® (a UV-protection process formulated to help prevent fading caused from the sun and other natural elements). The expandable gusset allows greater storage capacity when more room is needed. Detachable map

pocket is easily reversible for quick reference. Non-corrosive hardware will not rust or be beaten by the elements.

(Non-expanded size 10-3/4" x 4-1/2" x 12" – Fully-expanded size 10-3/4" x 7-1/2" x 12")

Ballistic Nylon Fabric

**GYP-5JJ64-11-BN** \$99.95

Fibertech™ Fabric

Designed to give the look of carbon fiber.

**GYP-5JJ64-11-CF** \$99.95

## 13. Motorcycle Cover

Made from durable water-resistant 250D polyester to keep your bike well protected from the elements. Elasticized bottom assures a snug fit. Built-in ventilation system prevents condensation. Locking grommet holes for extra security. Folds down to fit in its own compact and easy-to-carry storage pouch. Available in two sizes.

Extra Large

Fits touring bike with all accessories  
**MCV-UNIV2-PY-XL** \$59.95

Large

Fits most bikes up to 1000cc  
**MCV-UNIV2-PY-LG** \$53.95

### Star Custom Wheel Kits

Star custom wheels represent the pinnacle of style and innovation and employ state-of-the-art engineering and manufacturing processes. Crafted in the U.S.A. to demanding standards for exceptional quality using 100% CNC-machined 6061 forged aluminum. Available in brilliant chrome or contrast black anodized/raw machined aluminum, Star custom wheels are a bold statement in the personalization of your ride.

### Roadliner/ Stratoliner Custom Wheels & Accessories

Fits '06~'10 Roadliner and Stratoliner

#### Custom Wheels

- Front Wheel (Chrome) **5VN-F51C0-V0-00** \$1349.95
- Rear Wheel (Chrome) **1D7-F53S0-V0-00** \$1549.95
- Front Wheel (Midnight) **5VN-F51C0-U0-00** \$1299.95
- Rear Wheel (Midnight) **1D7-F53S0-U0-00** \$1499.95

#### Accessories

- Fits '06~'10 Roadliner and Stratoliner (Not shown)
- Rear Pulley (Chrome) **1D7-F54E0-V0-00** \$599.95
- Rear Pulley (Midnight) **1D7-F54E0-U0-00** \$549.95

### Raider Custom Wheels & Accessories

Fits '08~'10 Raider

#### Custom Wheels

- Front Wheel (Chrome) **5C7-F51C0-V0-00** \$1449.95
- Rear Wheel (Chrome) **5C7-F53S0-V0-00** \$1649.95
- Front Wheel (Midnight) **5C7-F51C0-U0-00** \$1399.95
- Rear Wheel (Midnight) **5C7-F53S0-U0-00** \$1599.95

#### Accessories

- (Not shown)
- Rear Pulley (Chrome) **5C7-F54E0-V0-00** \$599.95
- Rear Pulley (Midnight) **5C7-F54E0-U0-00** \$549.95

### Road Star Custom Wheels & Accessories

Fits '99~'10 Road Star models

#### Custom Wheels

- Front Wheel (Chrome) **5VN-F51C0-V0-00** \$1349.95
- Rear Wheel (Chrome) **5VN-F53S0-V0-00** \$1449.95
- Front Wheel (Midnight) **5VN-F51C0-U0-00** \$1299.95
- Rear Wheel (Midnight) **5VN-F53S0-U0-00** \$1399.95

#### Accessories

- (Not shown)
- Fits '99~'03 Road Star/Road Star Silverado
- Rear Pulley (Chrome) **1D7-F54E0-V0-00** \$599.95
- Rear Pulley (Midnight) **1D7-F54E0-U0-00** \$549.95
- Fits '04~'10 Road Star/Road Star Silverado
- Rear Pulley (Chrome) **5VN-F54E0-V0-00** \$599.95
- Rear Pulley (Midnight) **5VN-F54E0-U0-00** \$549.95

### Wheel and Tire Specifications

All wheels come with bearings, seals, and valve stems installed. Tires not included. (Metzeler 880 tires recommended).



**Chrome**



**Midnight**

Model	Front Rim Size	Recommended Front Tire Size	Rear Rim Size	Recommended Rear Tire Size
Roadliner / Stratoliner	18 X 3.5	140/70-18	18 X 5.5	200/50-18
Raider	21 X 3.5	120/70-21	18 X 8*	210/40-18
Road Star	18 X 3.5	140/70-18	18 X 4.25	160/60-18

\* Stock rim is 7.5; however, this rim takes the stock size tire.





Road Star shown with Star Custom Accessories, aftermarket accessories, and custom paint.

Yamaha is a name already known around the world for race-winning performance. Building on that name, Star Custom Accessories has an exceptional line of competition parts for our Star motorcycles: Speedstar. Speedstar products benefit from our history of engineering advances and our reputation for quality and workmanship, giving the racing enthusiast an edge.

Speedstar components have been precision-made to Star Motorcycles exacting standards so they fit right and give you a level of power and performance previously unavailable. To enjoy your Speedstar products to the fullest, be aware of any laws that might affect your use of these modifications as well as all requirements of the sanctioning organization for competition use. Also remember that modified motorcycles may need a higher level of maintenance to perform to the fullest.

### Performance Stages

Speedstar Competition Products are designed to work together in particular configurations, or stages, with each higher number stage providing a greater performance increase over stock. Speedstar products have been tested under controlled conditions in the specific stage configurations listed on the following pages. Using Speedstar components in configurations other than one of the specified stages can have a negative effect on the performance of your motorcycle and may even be harmful to the engine.

### Speedstar Limited Warranty Information

Speedstar components are covered by a 30-day limited warranty against defects in material or workmanship. Labor for replacement of defective components is not covered. The Star Motorcycles Limited Warranty provided with new Star motorcycles has exclusions for certain failures, including those caused by competition or racing use as well as by abnormal strain or abuse. While installation of these Speedstar Competition components will not "void" your motorcycle's warranty, specific failures determined by Yamaha to have resulted from the installation of kit components or other modifications, or from competition use may not be covered by warranty or extended service coverage.

Speedstar components are designed to be used together as a complete system as shown. Creating a combination not specified can adversely affect the performance of your motorcycle and may even be harmful to the engine. Components which affect emissions are for closed-course race application only.



### Caution:

- Speedstar engine-related competition parts are intended for closed-course racing applications only.
- All Star models are regulated by the EPA and state law. An alteration of emission-related components constitutes tampering under Federal and State laws and can lead to substantial fines and penalties if used other than in closed-course competition.
- Speedstar performance components are designed to be used as a complete system. Creating a combination not specified or tested can adversely affect the performance of your motorcycle and may even be harmful to the engine.
- Installation of Speedstar performance components requires extensive mechanical and tuning knowledge of 4-stroke motorcycle engines. A professionally trained motorcycle mechanic should install components and do any necessary tuning.
- Modified motorcycles may require premium unleaded fuel with a pump octane rating [R+M/2] of 91 or higher. Lower octane fuel can cause knocking and can result in engine damage (read installation instructions carefully for fuel requirements).

### Performance Charts

Performance charts have been included to provide you with helpful information on each Speedstar Competition stage configuration. Each chart contains the following:

- Horsepower in stock configuration
- Horsepower in stage configuration
- Torque in stock configuration
- Torque in stage configuration

Understanding the differences between torque and horsepower is important. Torque is essential to generating movement. It is what makes initial movement possible. Horsepower is important to continual motion. It is what keeps you moving.

### Road Star Warrior - Stock vs. Stage IV

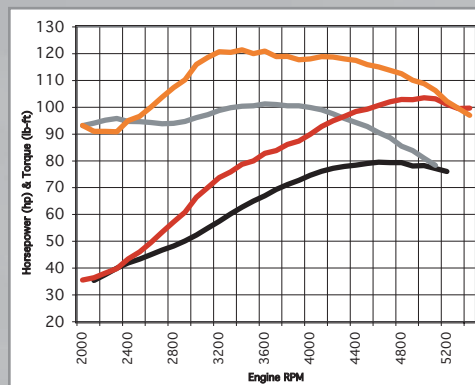

(Results Include a free-breathing 2-into-1 exhaust system)

**NOTE:** Corrected torque and horsepower were measured at the rear wheel on a Dynojet® Dynamometer. Your results may vary.

**'04~'07 Road Star - Stock vs. Stage I**

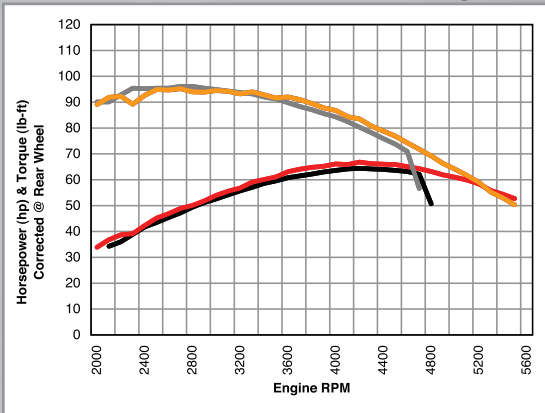

- Stock Horsepower
- Stock Torque
- Modified Stage Horsepower with Long Drag Pipes
- Modified Stage Torque with Long Drag Pipes (except Stage 1)

**'04~'07 Road Star - Stock vs. Stage II**

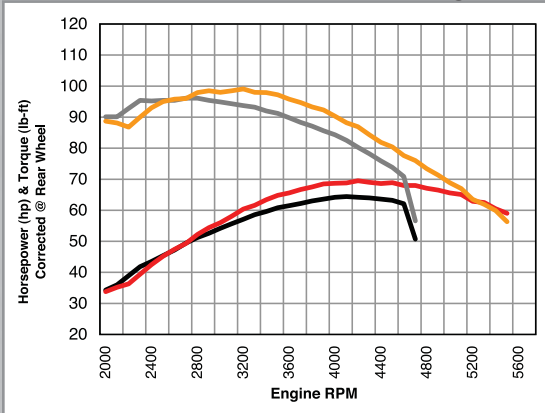

**'04~'07 Road Star - Stock vs. Stage III**

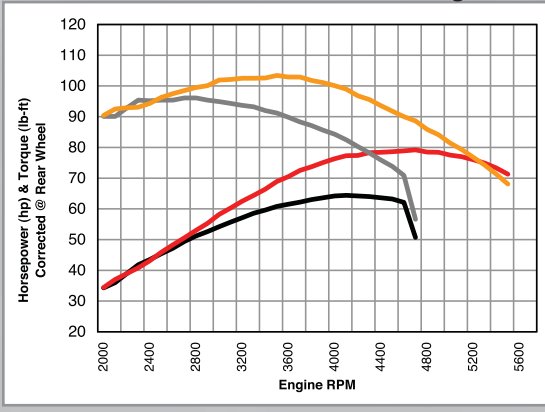

**'04~'07 Road Star - Stock vs. Stage IV**

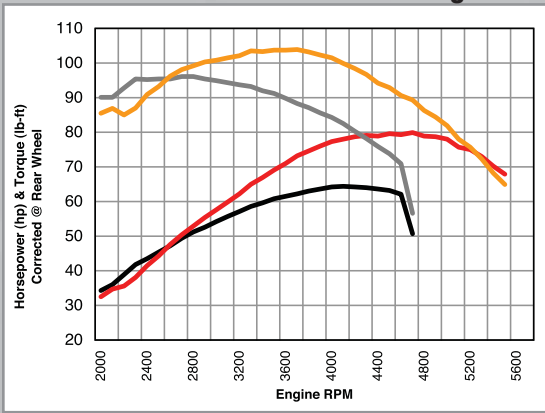

**'08~'10 Road Star - Stock vs. Stage I**

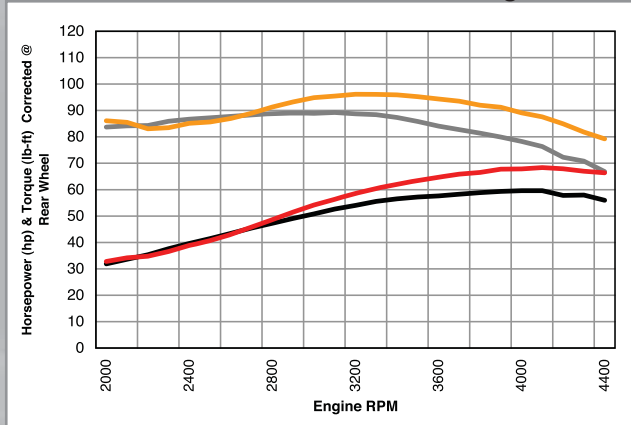

**'08~'10 Road Star - Stock vs. Stage II**

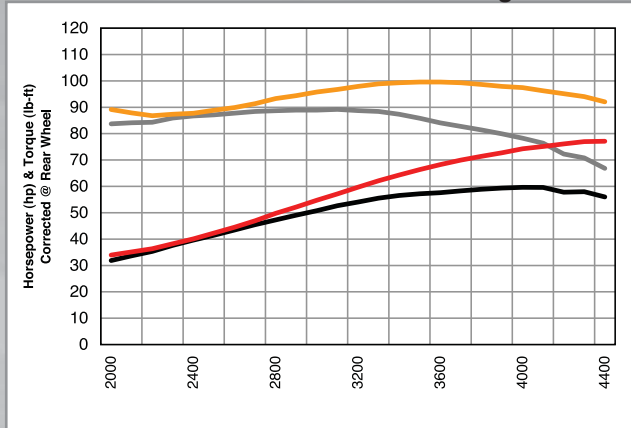

**'08~'10 Road Star - Stock vs. Stage III**

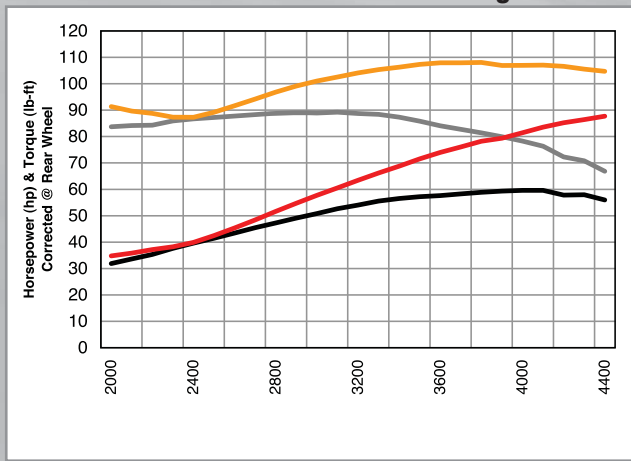

*IMPORTANT NOTE: All Star models are regulated by the EPA and state law. This accessory affects emissions and is for closed-course competition only. Use on public roads constitutes illegal tampering punishable by law.*



## 1. Warrior Stage IV Competition Configuration

('02~'09 Warrior)

This configuration increases torque and horsepower throughout the rpm range with a 25% increase in peak horsepower.

*For closed-course race application only (see Important Note below).*

Competition Velocity Stack Set  
**SPD-5PX09-76-10**

Speedstar Chrome Air Cleaner Assembly

**STR-5PX09-57-01**

Competition Stage IV ECU

**SPD-5PX09-50-04**

Competition High-Flow Fuel Injector Set

**SPD-5PX09-46-00**

Competition High-Compression Forged Piston Set

**SPD-5PX09-60-20**

Competition Clutch Spring

**SPD-5PX09-84-00**

Competition Valve Spring Set

**SPD-5PX09-14-10**

Competition Camshaft Set

**SPD-5PX09-10-14**

Competition Stage IV Gasket Kit

**SPD-5PX09-59-04**

## 3. Speedstar Chrome Air Cleaner Assembly

Replace the stock air cleaner with this sleek race-inspired piece. Use with the air filter element if using the stock air box, or remove the filter to use as a scoop to direct more air into the Competition Velocity Stacks.

Fits '02~'09 Warrior  
Chrome (Shown)

**STR-5PX09-57-01** \$182.95  
Onyx

**STR-5PX09-57-YB** \$193.95  
Replacement Filter Element

**5PX-14461-00-00** \$15.97

## 4. Competition Stage IV ECU

Stage IV Performance ECU (ignition module) offers an optimized fuel/ignition map to work with the higher compression ratio, increased airflow intake, and free-breathing exhaust system. Raises maximum rpm limit to 5500 rpm.

*For closed-course race application only (see Important Note below).*

Fits '02~'09 Warrior  
**SPD-5PX09-50-04** \$621.95

## Speedstar Competition Parts for Warrior

(Sold individually)

## 2. Competition Velocity Stack Set

Billet two-piece Velocity Stacks offer the best airflow for the ultimate in performance and power output. Includes pre-filters for limited air filtration.

*For closed-course race application only (see Important Note below).*

Fits '02~'09 Warrior  
**SPD-5PX09-76-10** \$246.95

## 5. Competition High Flow Fuel Injector Set

High-capacity fuel injectors (40% increase over stock) are designed to work with high-lift camshafts and the increased airflow. Fuel pressure regulator decreases fuel pressure by 20% from stock.

*For closed-course race application only (see Important Note below).*

Fits '02~'09 Warrior  
**SPD-5PX09-46-00** \$621.95

## 6. Competition High-Compression Forged Piston Set

These 10.2:1 forged pistons are designed to work with high-lift camshafts. Only 18 grams heavier than stock so no crank re-balancing is necessary. Includes stock rings, pins and clips.

*For closed-course race application only (see Important Note below).*

Fits '02~'09 Warrior  
**SPD-5PX09-60-20** \$374.95





### 7. Competition Clutch Spring

The spring rate is 20% stiffer than the stock spring for increased clutch capacity. Reduces clutch slippage and resultant heat build-up under heavy use. Designed to handle increased power output from Stage IV configuration.

Fits '02~'09 Warrior  
SPD-5PX09-84-00 \$123.95

### 8. Competition Valve Spring Set

Designed to accommodate higher lift camshafts (up to 9.3mm lift) and up to 5500 rpm. Seat pressure is increased by 20% over stock.

Fits '02~'09 Warrior  
SPD-5PX09-14-10 \$257.95

### Competition Stage IV Gasket Kit

(Not shown)

Complete kit of gaskets necessary for installation of Stage IV components.

Fits '02~'09 Warrior  
SPD-5PX09-59-04 \$86.95



### 9. Competition Camshaft Set

Includes both front and rear cams. Offers increased mid-range and top-end power from 3200 rpm up. Produces peak horsepower around 5500 rpm. Must use Competition Valve Springs with these camshafts. Uses the stock decompression mechanism for easy starting, yet higher performance.

*For closed-course race application only (see Important Note below).*  
Fits '02~'09 Warrior  
IQG-00094-73-20 \$521.99

Speedstar components are designed to be used together as a complete system as shown. Creating a combination not specified can adversely affect the performance of your motorcycle and may even be harmful to the engine. Components which affect emissions are for closed-course race application only.

### 102 cu. in. Road Star Stage I Competition Con- figuration

('08~'10 XV1700 Road Star)

This configuration increases torque and horsepower throughout the rpm range, with up to a 15% increase at the peak over stock.

*For closed-course race application only (see Important Note below).*

Competition Long Drag Pipes  
**SPD-5VN09-90-03**

### 102 cu. in. Road Star Stage I Competition Con- figuration

('04~'07 XV1700 Road Star)

This configuration increases torque and horsepower throughout the rpm range, with a 5% increase at the peak over stock.

*For closed-course race application only (see Important Note below).*

Speedstar Stage I Installation  
Instructions  
**PAK-5VN09-00-01**  
Competition Carburetor Jet Kit  
**SPD-4WM09-49-10**  
Competition Ignition Module  
**SPD-4WM09-50-03**

Speedstar Competition Air Filter  
(Choose from several cover designs)  
Speedstar Competition Air Filter with  
Speedstar Cover

**SPD-5VN09-47-05**

Speedstar Competition Air Filter with  
Ball Milled Cover

**SPD-5VN09-47-02**

Speedstar Competition Air Filter with  
Flamed Cover

**SPD-5VN09-47-04**

Speedstar Competition Air Filter with  
"102 cu. in." Cover

**SPD-5VN09-47-03**

*See pages 148 through 152 for  
product details.*

### 102 cu in. Road Star Stage II Competition Configuration

('08~'10 XV1700 Road Star)

This configuration increases torque and horsepower throughout the rpm range, with up to 29% increase at the peak over stock.

*For closed-course race application only (see Important Note below).*

Competition Long Drag Pipes  
**SPD-5VN09-90-03**

Speedstar Competition Air Filter  
(Choose from several cover designs)  
Speedstar Competition Air Filter with  
Speedstar Cover

**SPD-5VN09-47-05**

Speedstar Competition Air Filter with  
Ball Milled Cover

**SPD-5VN09-47-02**

Speedstar Competition Air Filter with  
Flamed Cover

**SPD-5VN09-47-04**

Speedstar Competition Air Filter with  
"102 cu. in." Cover

**SPD-5VN09-47-03**

Power Commander®

**SPD-5VN09-52-00**

Competition Clutch Spring

**SPD-5PX09-84-00**

### 102 cu in. Road Star Stage II Competition Configuration

('04~'07 XV1700 Road Star)

This configuration increases torque and horsepower throughout the rpm range, with up to an 8% increase at the peak over stock.

*For closed-course race application only (see Important Note below).*

Speedstar Stage II Installation  
Instructions

**PAK-5VN09-01-02**

Competition Carburetor Jet Kit

**SPD-4WM09-49-10**

Competition Ignition Module

**SPD-4WM09-50-03**

Speedstar Competition Air Filter  
(Choose from several cover designs)  
Speedstar Competition Air Filter with  
Speedstar Cover

**SPD-5VN09-47-05**

Speedstar Competition Air Filter with  
Ball Milled Cover

**SPD-5VN09-47-02**

Speedstar Competition Air Filter with  
Flamed Cover

**SPD-5VN09-47-04**

Speedstar Competition Air Filter with  
"102 cu. in." Cover

**SPD-5VN09-47-03**

Competition Long Drag Pipes

**SPD-5VN09-90-02**

*See pages 148 through 152 for  
product details.*

**102 cu. in. Road Star  
Stage III Competition  
Configuration**

('08~'10 XV1700 Road Star)

This configuration increases torque and horsepower throughout the rpm range, with up to 53% increase at peak over stock.

*For closed-course race application only (see Important Note below).*

Competition Long Drag Pipes

**SPD-5VN09-90-03**

Speedstar Competition Air Filter

(Choose from several cover designs)

Speedstar Competition Air Filter with

Speedstar Cover

**SPD-5VN09-47-05**

Speedstar Competition Air Filter with

Ball Milled Cover

**SPD-5VN09-47-02**

Speedstar Competition Air Filter with

Flamed Cover

**SPD-5VN09-47-04**

Speedstar Competition Air Filter with

"102 cu. in." Cover

**SPD-5VN09-47-03**

Power Comander®

**SPD-5VN09-52-00**

Competition High-Compression

Forged Piston Set

**SPD-5PX09-60-20**

Competition High-Flow Intake

Manifold

**SPD-5VN09-74-10**

Competition Throttle Body

**SPD-5VN09-44-00**

Competition Stage IV Clutch Spring

**SPD-4WM09-84-00**

Competition Camshaft Set

**IQG-00094-73-20**

Competition Dual Valve Spring Set

**SPD-5PX09-14-10****102 cu. in. Road Star  
Stage III Competition Con-  
figuration**

('04~'07 XV1700 Road Star)

This configuration increases torque and horsepower throughout the rpm range, with up to 20% or 32% (2-1-2 MegaCone Pipes) increase at the peak over stock.

*For closed-course race application only (see Important Note below).*

Speedstar Stage III Installation

Instructions

**PAK-5VN09-01-03**

Competition Ignition Module

**SPD-4WM09-50-03**

Competition 42mm Mikuni® HSR

Carburetor

**SPD-4WM09-42-01**

Competition High-Compression

Forged Piston Set

**SPD-5PX09-60-20**

Competition High-Flow Intake

Manifold

**SPD-5VN09-74-00**

Competition Stage III Gasket Kit

**SPD-5VN09-59-04**

Speedstar Competition Air Filter

(Choose from several cover designs)

Speedstar Competition Air Filter with

Speedstar Cover

**SPD-5VN09-47-05**

Speedstar Competition Air Filter with

Ball Milled Cover

**SPD-5VN09-47-02**

Speedstar Competition Air Filter with

Flamed Cover

**SPD-5VN09-47-04**

Speedstar Competition Air Filter with

"102 cu. in." Cover

**SPD-5VN09-47-03**

Competition Long Drag Pipes

**SPD-5VN09-90-02**

*See pages 148 through 152 for product details.*

**102 cu. in. Road Star  
Stage IV Competition  
Configuration**

('04~'07 XV1700 Road Star)

This configuration increases torque and horsepower throughout the rpm range, with up to 24% increase at peak over stock.

*For closed-course race application only (see Important Note below).*

Speedstar Stage IV Installation

Instructions

**PAK-5VN09-01-04**

Competition Ignition Module

**SPD-4WM09-50-03**

Competition 45mm Mikuni® HSR

Carburetor

**SPD-4WM09-45-01**

Competition High-Compression

Forged Piston Set

**SPD-5PX09-60-20**

Competition High-Flow Intake

Manifold

**SPD-5VN09-74-00**

Competition Stage IV Gasket Kit

**SPD-5VN09-59-04**

Competition Tall Air Filter

**SPD-4WM09-48-00**

Competition Stage IV Clutch Spring

**SPD-4WM09-84-10**

Competition Billet Air Filter Back-

plate

**SPD-4WM09-47-00**

Competition Camshaft Set

**SPD-5PX09-10-14**

Competition Dual Valve Spring Set

**SPD-5PX09-14-10**

Speedstar Competition Air Filter

(Choose from several cover designs)

Speedstar Competition Air Filter with

Speedstar Cover

**SPD-5VN09-47-05**

Speedstar Competition Air Filter with

Ball Milled Cover

**SPD-5VN09-47-02**

Speedstar Competition Air Filter with

Flamed Cover

**SPD-5VN09-47-04**

Speedstar Competition Air Filter with

"102 cu. in." Cover

**SPD-5VN09-47-03**

Competition Long Drag Pipes

**SPD-5VN09-90-02**

Competition 2-1-2 MegaCone Pipes

**SPD-4WM09-90-04**

*See pages 148 through 152 for product details.*

## 1. Competition Carburetor Jet Kit

A premium race tuner's Jet Kit for the stock carburetor. Includes all OEM Mikuni® jets (4 mains and 2 pilots) and a specially designed titanium needle. Necessary for tuning with free-breathing intake and exhaust systems.

*For closed-course race application only (see Important Note below).*

Fits '99~'07 Road Star models

SPD-4WM09-49-10 \$53.95



## 2. Competition Ignition Module

This module increases the rev limit to 5500 rpm and provides increased spark energy to optimize the performance of all Speedstar kits.

*For closed-course race application only (see Important Note below).*

Fits '99~'07 Road Star models

SPD-4WM09-50-03 \$321.95



## Speedstar Competition Air Filter

Provides increased airflow and performance. Works with stock plastic mount or Competition Billet Air Filter Backplate. Features washable high-flow K&N® air filter element, and chrome-plated billet cover. Includes all mounting hardware. Choose from several cover designs.

## 3. Speedstar Competition Air Filter with Speedstar Cover

Fits '99~'07 Road Star models

SPD-5VN09-47-05 \$182.95

## 4. Speedstar Competition Air Filter with Ball Milled Cover

Fits '99~'07 Road Star models

SPD-5VN09-47-02 \$182.95

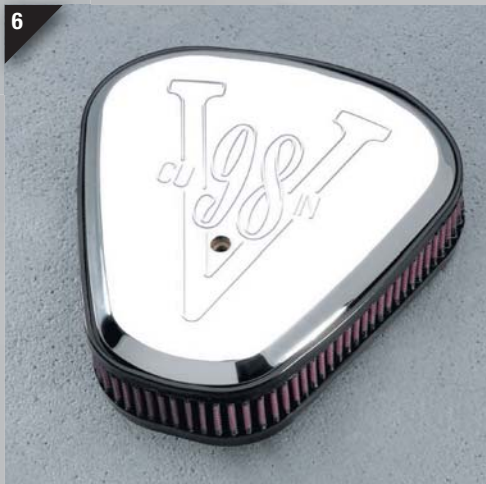
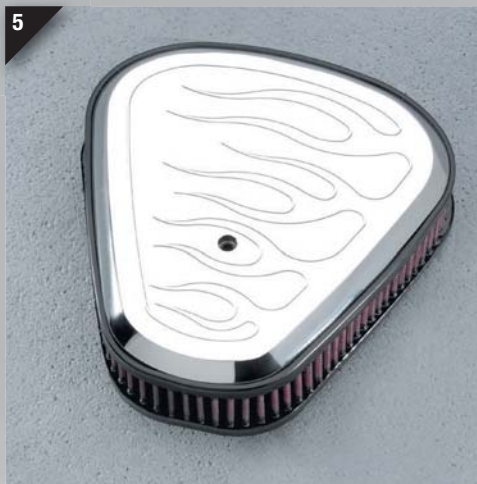

## 5. Speedstar Competition Air Filter with Flamed Cover

Fits '99~'07 Road Star models

SPD-5VN09-47-04 \$182.95

## 6. Speedstar Competition Air Filter with "V 98 cu. in." Cover

Fits '99~'03 Road Star models

SPD-4WM09-47-03 \$182.95

## 7. Speedstar Competition Air Filter with "V 102 cu. in." Cover

Fits '04~'10 Road Star models  
SPD-5VN09-47-07 \$205.95

## 8. Replacement Competition Air Filter

Washable high-flow K&N® air filter; same as filter supplied in Air Filter kits.

Fits '99~'10 Road Star models using Speedstar Competition Air Filter  
SPD-4WM09-47-F2 \$65.95

## 9. Competition Billet Air Filter Backplate

Precision machined from 6061-T6 Billet Aluminum and black anodized. Designed to work with the Mikuni® HSR carburetors. Moves the air filter element 1 inch closer to the center of the bike to allow for more rider comfort.

Fits '99~'07 Road Star models using Speedstar Competition Air Filter  
SPD-4WM09-47-00 \$169.95

## 10. Competition Tall Air Filter

Performance upgrade for the Speedstar Competition Air Filter. Doubles the filter area for more air-flow to provide a 1.5 hp increase in peak power. Use with the Speedstar Competition Air Filter's billet cover. The Competition Billet Air Filter Backplate (SPD-4WM09-47-00) is highly recommended.

Fits '99~'07 Road Star models using Speedstar Competition Air Filter  
SPD-4WM09-48-00 \$86.95

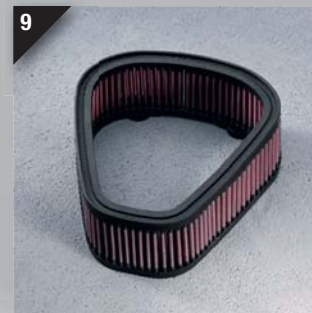

## 10. Competition Long Drag Pipes

Designed to maximize exhaust flow for increased performance, with more mid-range torque and higher overall power. This system features 1-3/4" header pipe with 2-1/2" heat shields. Heat shields are constructed of heavy-gauge steel, and then are polished and richly chrome-plated for an extra durable, shiny finish. Baffles are non-removable. Comes complete with mounting bracket and hardware.

*For closed-course race application only (see Important Note below).*

Fits '08~'10 Road Star models  
SPD-5VN09-90-03 \$618.95  
Fits '99~'07 Road Star models  
SPD-5VN09-90-02 \$480.95

## 11. Competition Mikuni® HSR Flatslide Carburetion

Exceptional throttle response and drivability. Works with stock throttle cables. Includes all mounting brackets and additional jets to tune for optimal performance at the track.

*For closed-course race application only (see Important Note below).*

Fits '99~'07 Road Star models.

### 42mm

Designed and jetted to work with Stage III configuration.  
SPD-4WM09-42-01 \$443.95

### 45mm

Designed and jetted to work with Stage IV configuration.  
SPD-4WM09-45-01 \$503.95

Speedstar components are designed to be used together as a complete system as shown. Creating a combination not specified can adversely affect the performance of your motorcycle and may even be harmful to the engine.

### 1. Road Star Power Commander® by Dynojet® Research, Inc.

This Power Commander® plugs in-line with your Road Star's stock fuel injection system. It uses the stock style connectors, making installation easy and quick. Comes preloaded with recommended maps for four different configurations ready to install from the CD included in the package. The PCIII USB allows a full range of fuel adjustments. Adjustments can be made with either a Windows-based computer or by using the faceplate-mounted button adjusters. No permanent changes are made to the bike's system. Once the unit is removed, the bike reverts to its stock settings.

*For closed-course race application only (see Important Note below).*

Fits '08~'10 Road Star models  
**SPD-5VN09-52-00**     \$354.95

### 2. Throttle Body

This new 45mm throttle body maximizes performance gains when used with Speedstar high-compression forged pistons and competition forged pistons and competition camshaft sets. Requires the use of Competition High-Flow Intake Manifold (SPD-5VN09-74-10). Recommend for use with modified engines.

*For closed-course race application only (see Important Note below).*

Fits '08~'10 Road Star models  
**SPD-5VN09-44-00**     \$854.95

### 3. Competition High-Compression Forged Piston Set

These 10.25:1 forged pistons come with deeper valve pockets to work with high-lift camshafts. Only 2 grams heavier than stock, so no crank re-balancing is necessary. Special rings are included to work with chrome bore. Also includes pins and clips.

*For closed-course race application only (see Important Note below).*

Fits '04~'10 Road Star models  
**SPD-5PX09-60-20**     \$374.95  
 Fits '99~'03 Road Star models  
**SPD-4WM09-60-10**     \$374.95

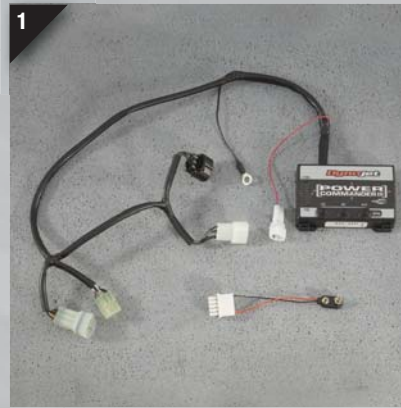

#### 4. Competition High-Flow Intake Manifold

a. High-flow intake manifold. Requires the use of Throttle Body (SPD-5VN09-44-00).

*For closed-course race application only (see Important Note below).*

Fits '08~'10 Road Star models  
**SPD-5VN09-74-10**     \$366.95

b. High-flow intake manifold designed to work with either the 42mm or 45mm HSR Flatslide Carburetor and CNC-Ported Cylinder Heads. Molded of rubber with steel insert like original equipment to allow for engine vibration and thermal expansion. Flow is increased over the stock manifold.

*For closed-course race application only (see Important Note below).*

Fits '04~'07 Road Star models  
**SPD-5VN09-74-00**     \$139.95  
Fits '99~'03 Road Star models  
**SPD-4WM09-74-00**     \$125.95

#### 5. Competition Camshaft Set

Includes both front and rear billet cams made from billet for exceptional durability, which uses the stock decompression mechanism for easy starting, yet high performance. Offers increased mid-range and top-end power from 3200 rpm up. Produces peak horsepower around 5500 rpm.

Fits '04~'10 Road Star models  
**IQG-00094-73-20**     \$521.99  
Must use Competition Dual Valve Springs with these camshafts.



Speedstar components are designed to be used together as a complete system as shown. Creating a combination not specified can adversely affect the performance of your motorcycle and may even be harmful to the engine.





## 1. Competition Dual Valve Spring Set

Designed to accommodate cams up to 9.3mm lift and up to 5500 rpm. Seat pressure is increased by 20% over stock.

*For closed-course race application only (see Important Note below).*

Fits '04~'10 Road Star models  
**SPD-5PX09-14-10** \$257.95

## 2. Competition Clutch Spring

Offers increased clutch capacity. Reduces clutch slippage and resultant heat build-up under heavy use.

### Stage III for 102 cu. in.

The spring rate is 20% stiffer than the stock spring for increased clutch capacity. Reduces clutch slippage and resultant heat build-up under heavy use. Designed to handle increase power output from Stage III configuration.

Fits '08~'10 models  
**SPD-5PX09-84-00** \$123.95

### Stage III for 98 cu. in.

The spring rate is about 7% stiffer than the stock spring for the 98 cu. in. engine to handle the increased power output from Stage III configuration.

Fits '99~'03 Road Star models  
**SPD-4WM09-84-00** \$69.95

### Stage IV for 98 cu. in. and 102 cu. in.

The spring rate is about 25% stiffer than the stock spring to handle the increased power output from Stage IV configuration.

Fits '99~'07 Road Star models  
**SPD-4WM09-84-10** \$113.95

## Competition Gasket Kits (Not shown)

### Stage III or IV for 102 cu. in.

Complete kit of gaskets necessary for installation of Stage III or IV components.

Fits '04~'07 Road Star models  
**SPD-5VN09-59-04** \$75.95

## Speedstar Installation Instructions for Road Star Models (Not shown)

### Stage I Kit Configuration

For '04~'07 Road Star models  
**PAK-5VN09-00-01** \$2.95

### Stage II Kit Configuration

For '04~'07 Road Star models  
**PAK-5VN09-01-02** \$2.95

### Stage III Kit Configuration

For '04~'07 Road Star models  
**PAK-5VN09-01-03** \$2.95

### Stage IV Kit Configuration

For '04~'07 Road Star models  
**PAK-5VN09-01-04** \$10.95

Speedstar components are designed to be used together as a complete system as shown. Creating a combination not specified can adversely affect the performance of your motorcycle and may even be harmful to the engine.